

# IEFIS MX1 panel user manual



This document details the user interface for an iEFIS MX1 panel.

Preliminary documentation  
Document date: 25 July 2019

# Table of Contents

General.....	5
IEFIS capabilities.....	5
IEFIS MX1 documentation.....	6
The iEFIS MX1 panel in detail.....	8
Touch screen .....	8
Rotary controls.....	8
Soft key fields.....	9
Micro SD card slot.....	9
Example system design.....	9
IEFIS MX1 default screens.....	10
Typical Screen items.....	11
Adjusting local pressure (QNH or baro pressure).....	12
Changing pages.....	12
The primary flight display.....	13
Weight and Balance.....	14
GPS status.....	15
The GPS status line:.....	15
GPS source: .....	15
GPS Fix quality.....	15
RAIM information.....	15
GPS status dialog.....	16
COM radios.....	16
COM radio dialog.....	17
NAV radio.....	19
Transponder.....	20
ADSB.....	22
Waypoint information.....	23
Retracking a waypoint and GPS OBS.....	23
GPS mark position.....	24
Flight plans.....	25
The Flightplan manager.....	25
Activate Flightplan, Activate Flightplan in reverse.....	26
Create a new Flightplan.....	26
View or Edit a Flightplan.....	27
Copy a Flightplan.....	27
Delete a Flightplan.....	27
Import GPX format Flightplan.....	27
Import Seattle Avionics Flightplan (FDX).....	27
Canceling an active flight plan.....	27
The Flightplan popup.....	28
Waypoints behind are not forgotten.....	31
The menu system.....	32
Supplementary Waypoint editor.....	33
Primary Navidata waypoint viewer.....	33
Secondary Navidata waypoint viewer.....	33

Information system menu.....	33
Common Tasks.....	33
Install Tasks.....	34
System setup menu.....	34
3D View setup.....	34
File manager.....	34
Engine and airframe timers.....	34
Daylight backlight setting.....	34
Nighttime backlight setting.....	34
System Diagnostics.....	35
The Flightplan Tool.....	36
ADD Waypoint.....	37
Add using Text entry.....	37
Add map position.....	38
Add from navigation database.....	38
Add map Airport, Navaid, reporting point, etc.....	38
Edit and Delete waypoint.....	38
Latitude and Longitude.....	38
Center map at GPS pos.....	38
Map options.....	39
Working with maps.....	40
Mode.....	41
Airprt.....	41
AirSP.....	41
Divert.....	42
Retrack.....	43
PAN.....	43
Map information mode.....	44
Airport.....	45
Airspace.....	45
Goto.....	45
MakeWP.....	45
Clear.....	45
Panning the map.....	46
P-off.....	47
P-hold.....	47
P-go.....	47
Map Display in Panning mode.....	48
The rotary controls.....	49
Normal page mode.....	49
Map mode.....	49
Menu mode.....	49
Other modes.....	49
Waypoint selection system.....	50
Waypoint search.....	52
The installation tasks menu.....	53
Install NaviData database(s).....	53

Install supplementary waypoint file.....	54
Install weight and balance files.....	54
Install or remove raster maps.....	54
Delete current screen files in screens folder.....	54
Install screen files to screen folder.....	55
Install World image (Map).....	55
Install sound file from SD/MMC card.....	55
Common tasks menu.....	56
UTC offset.....	56
Flight log pilot number.....	56
Export Flight Folio to SD card.....	56
Copy internal Flight Data recording to SD card.....	56
3D View setup.....	57
Attitude graticule display.....	58
View uses pressure altitude.....	58
Show.....	58
Flight path display.....	58
Flight director.....	58
Allow helicopter pads.....	58
Show 3D highway in the sky.....	59
HITS follows altitude bug.....	59
Velocity.....	59
Pitch ladder banks.....	60
Enable 2D traffic on SV.....	60

## General

The iEFIS MX1 system consists of one or more panels as well as sensors and control interfaces as required.

As of writing of this document the following MGL devices are compatible with the iEFIS MX1 system:

Up to 8 panels may be connected in a single system

SP-6 CAN: Compass/Magnetometer

SP-7 CAN: AHRS

SP-9 CAN: High grade AHRS and SP-6 compass combo.

SP-10 CAN: Flap, trim and gear controller (up to 6 units, up to 2 functions/unit, 6 functions max)

RDAC XF, RDAX XG: Engine monitoring interface (up to 4 units/engines)

RDAC CAN: ECU interface (up to 2 units/engines)

MGL V6: COM radio (including full remote control)

MGL V10: COM radio (including full remote control)

MGL V16: COM radio (Remote control or combo with Vega or Razor control head)

MGL N16: NAV radio (ILS,VOR). Remote unit or combo with V16 with or without heads.

MGL ECB system (up to 4 units, 48 breakers)

MGL Autopilot servos (Bank, Pitch, Yaw)

MGL/Garrecht mode-s transponder

MGL/Trig mode-s transponder

MGL T16: Mode-S transponder

MGL A16 Intercom system

Remote transponders via MGL CAN bus interface (check for availability with MGL)

Remote COM radios via MGL CAN bus interface (check for availability with MGL)

The following third party products are compatible with the iEFIS system:

Garmin SL40, GTR-200, GTR255 and compatible COM radio

Garmin SL30, GNC-255 and compatible NAV/COM radio

Traffic systems: GDL90 ADSB, FLARM

ADSB UAT receivers or transceivers via GDL90

External autopilots able to use RS232 NMEA feed for lateral navigation can be used as well for all GPS based navigation sources (except simulated VOR).

Sandia aerospace STX-165R mode-c transponder

## IEFIS capabilities

Based on a powerful platform , iEFIS introduces a modular, yet low cost approach to the aircraft avionics panel. The principle guidance during the iEFIS development was “complete, one stop, any function, any aircraft”. From ultralights to space craft, this system covers all.

IEFIS MX1 can be combined in the cockpit as required.

The MX1 contains interfaces for many devices as well as pressure sensors for altimeter, airspeed and angle of attack. Airspeed can be measured to several Mach numbers at altitude while the pressure based altimeter reaches to over 40.000 ft with a resolution of just 1 ft. The iBOX also contains one of the highest performance GPS receivers available today, able to track GPS satellites of several countries as well as providing WAAS and RAIM capability. The MX1 also contains a built in AHRS.

Redunant systems may be created in a variety of ways using multiple panels.

IEFIS may be used to comprehensively monitor up to 4 engines, 8 physical fuel tank levels and 8 virtual tanks (based on fuel flow measurements).

Up to 4 external AHRS units may be fitted for high redundancy systems as well as multiple magnetometers.

A multitude of interfaces allows the iEFIS system to control or monitor any conceivable aircraft system.

A comprehensive built in autopilot requires just the addition of servos to complete.

Any conceivable navigation source from GPS based to traditional navigation radios may be connected in a variety of ways.

EFIS controlled COM radios, NAV radios and transponders, both mode-c and mode-s may be fitted for a complete, cost effective solution.

The modular concept of iEFIS allows not just a tailormade solution, if desired each panel can be customised by the owner using a freely available "screen design" tool. However, despite this the iEFIS contains many built in screen layout options for engine and fuel systems that can be simply selected during installation. This allows turn key solutions for most typical applications.

Installation of an iEFIS system poses greatly reduced effort compared to traditional systems. Wiring requirements are minimal as most devices are connected to a common two wire CAN bus.

## **IEFIS MX1 documentation**

Due to the nature of the iEFIS MX1 system, documentation is split into several independent documents.

Please refer to the following:

iEFIS MX1 User manual (this document)

MGL iEFIS Autopilot manual.

iEFIS MX1 Installation manual

iEFIS Alteration guide (needed if custom screen designs are to be attempted)

Many more manuals related to specific areas of interest related to iEFIS systems are available on the MGL website IEFIS documents page.

In addition please refer to the manuals related to individual devices and interfaces.  
Manuals are available on the MGL Avionics home website: [www.MGLAvionics.co.za](http://www.MGLAvionics.co.za)

## The iEFIS MX1 panel in detail

This image shows the MX1 panel.

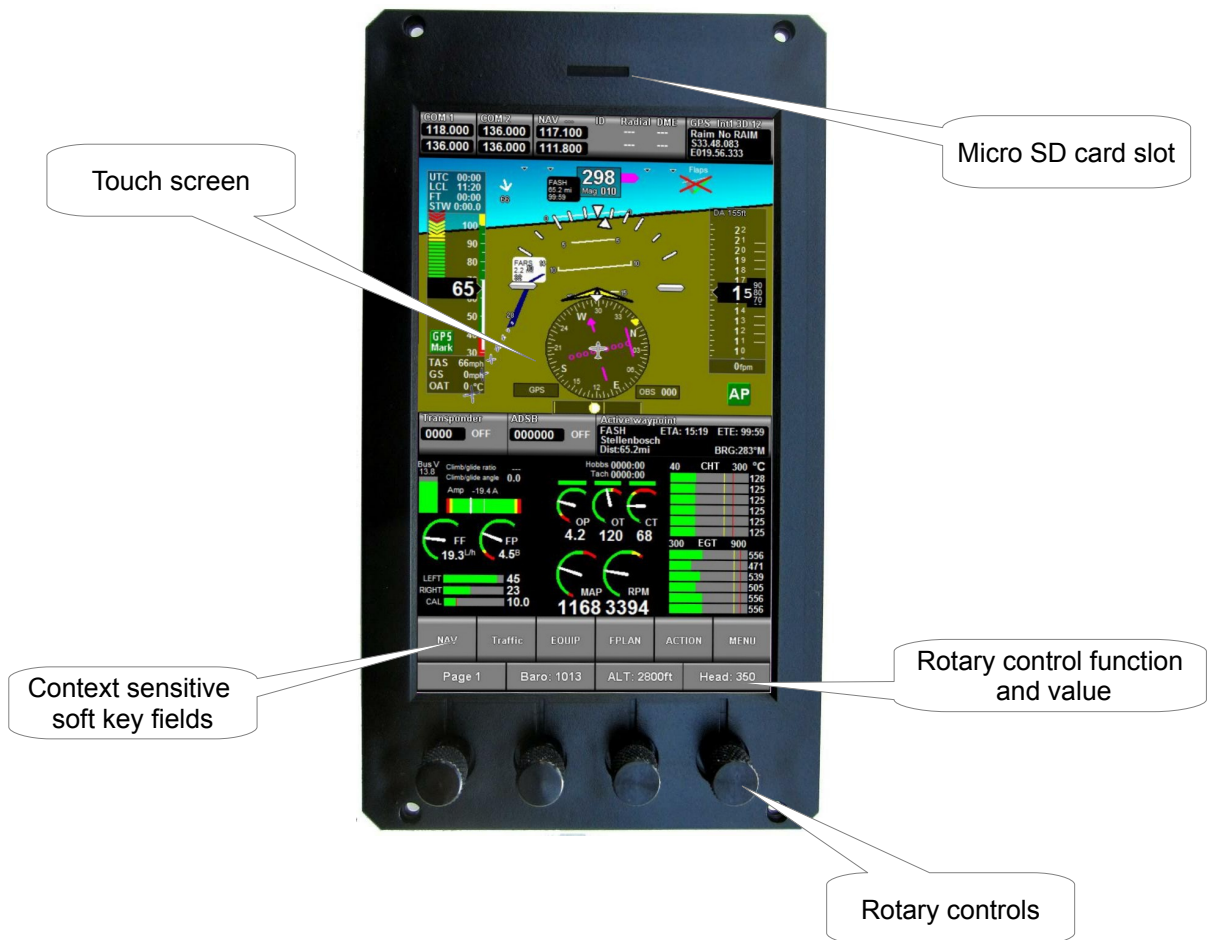

### ***Touch screen***

The touch screen of the iEFIS panels is a projected capacitive touch panel device. It requires finger touch and will not respond to use of ordinary gloves (but gloves made for use with touch screens are available).

The touch screen may be used in all ambient pressure conditions including vacuum and is tolerant to rapid decompression.

### ***Rotary controls***

The 4 rotary controls have strong indents during rotation to allow positive selection of a desired value. Many rotary functions have a dual level. The second level can be obtained by pressing the rotary control towards the panel while turning. For example, this is used when selecting a COM frequency: First select the MHZ, then press and turn to select the KHZ.



## Soft key fields

This area of the screen is used with most displays and contains context sensitive functionality. For example, if you touch on a map area these fields change functionality to map based functions like pan and zoom.

## Micro SD card slot

The micro SD card slot can accept SD micro cards as well as SDHC micro cards. These cards are used mainly to transfer files to and from the panel such as maps. A permanently inserted card can also be used to record black box style flight data during flight (in addition to the built in black box recording).

## Example system design

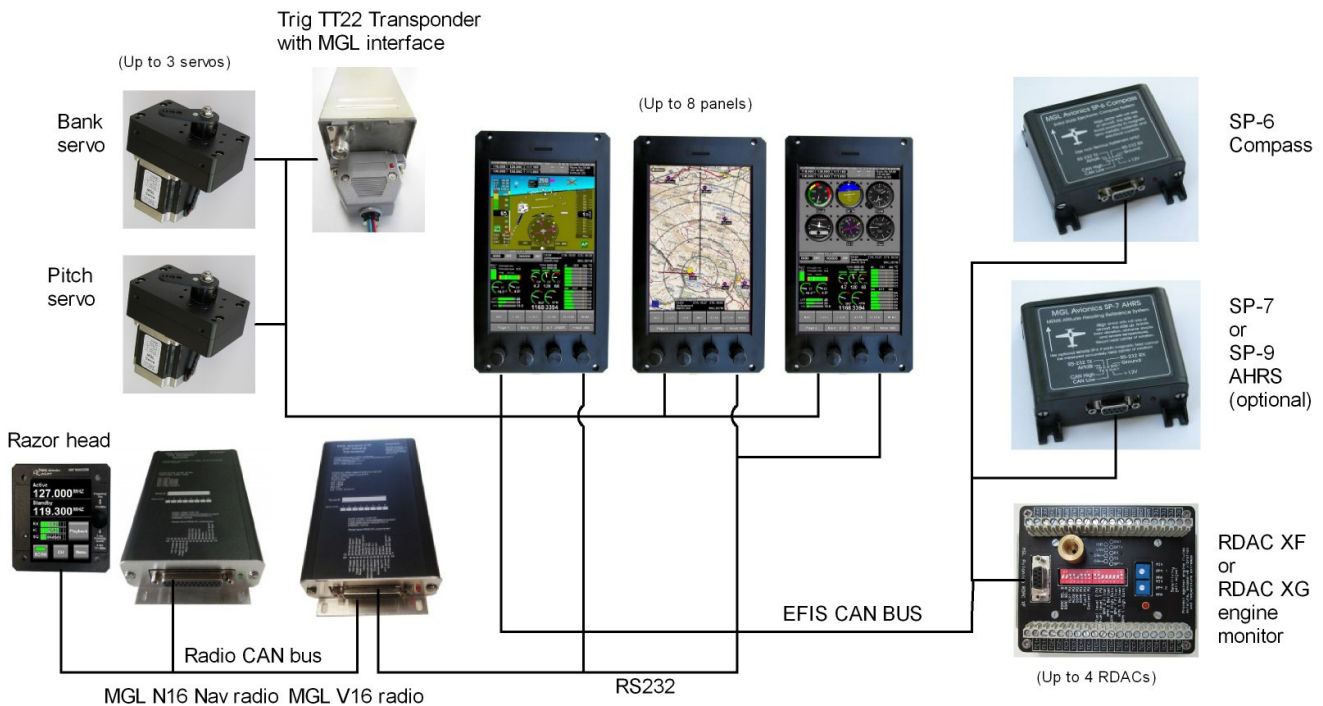

Example iEFIS MX1 system layout for a three panel solution, showing main communications bus connections.

The above image shows a typical small three panel system. Please refer to the iEFIS MX1 installation manual for details.

# IEFIS MX1 default screens

Default screens refer to screen layouts that are “built-in” to a panel. Various types of default screens and parts of default screens can be chosen in the system setup. Layouts refer to the general organization of a screen while details refer to parts of a screen. A detail may relate to the monitoring for a particular engine type or a fuel system setup.

If none of the built in layouts and/or details are suitable, a custom layout may be performed using the screen designer tool. This may base a modified screen on an existing screen or it may be completely new screen that has been created from scratch.

This document refers to the built in screens. While custom screens may be similar, please refer to the company or person that designed your screens for details should this be needed.

Note: The built in screens have a single default layout and a total of 4 pages as shown below. In the screen layout menu (Under system setup) you can choose from a variety of built in engine and fuel system layouts.



## Typical Screen items

Navigation sources available for selection in your system are selected in the NAV menu. To activate the NAV menu at any time, just tap the NAV soft key field.

You can tap on the active HSI indicator at any time to select a new navigation source or use the NAV menu

HSI = Horizontal Situation Indicator

Note: The internal autopilot follows the HSI, switching the HSI to a source that has no valid solution will disengage the autopilot as it no longer has a navigation source to follow.

The system supports four navigation sources (each of these may have more than one physical source).

GPS: This refers to common GPS based "Goto" or "Flightplan" navigation.

VOR: This refers to following a VOR radial from a NAV radio or simulated VOR using GPS.

ILS: This refers to following a runway localizer and optionally a glide slope. This can be sourced from a NAV radio or simulated via GPS and the built in "GLS" system.

Heading bug: This allows following a ground track or heading vector.

Please refer to the iEFIS Navigation manual for details on using the navigation system.



This field shows UTC time from GPS, your local time (kept in the iBOX), flight time if a flight is active and also a stop watch. Tap in this field to bring up:

Tap here when done

This pop up allows you to start, stop and reset the stopwatch.

Further to this you have a count down timer. You can set this timer to a starting value and it will count down, proceeding to go negative if it goes below zero. The count down timer only shows when it is running:



Count down timer shows when running



Stop watch and count down timer resolutions are to 0.1 second.

These timers are located in the iBOX and apply system wide. You can start/stop timers from any panel.

## Adjusting local pressure (QNH or baro pressure)

Adjust local pressure using the rotary control:



If you do not see the baro pressure tab over the rotary control, press the “Page” rotary control to select a rotary control page that does have this control present. Note: Adjusting local pressure is not available if you are inside any menu system or dedicated function such as the Flight planning tool.

## Changing pages

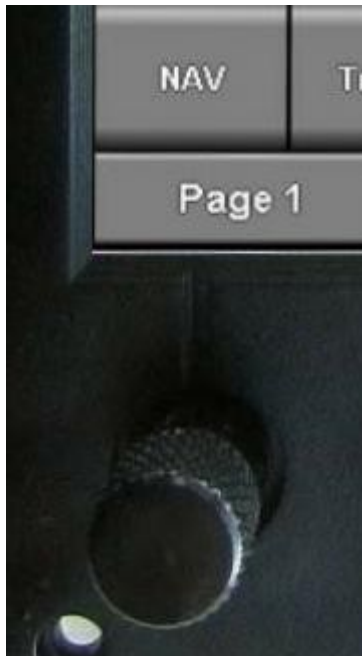

Change pages by rotating the rotary control shown to the left.

The built in default system has 4 pages. Custom systems may have up to 9 pages. You can create new pages or edit existing ones including the built in defaults to your liking using the MX1 Screen designer and simulator available for free from the MGL Website.

Note: This rotary control has a secondary function:

If you press the rotary control you can change the functions of the other rotary controls – for example you can change to using the rotary controls to set the OBS (omnidirectional bearing select).

Further to this, if you have a multi-panel system it will show the panel address next to the page number as well as an indication if the panel is a master or secondary panel.



## The primary flight display

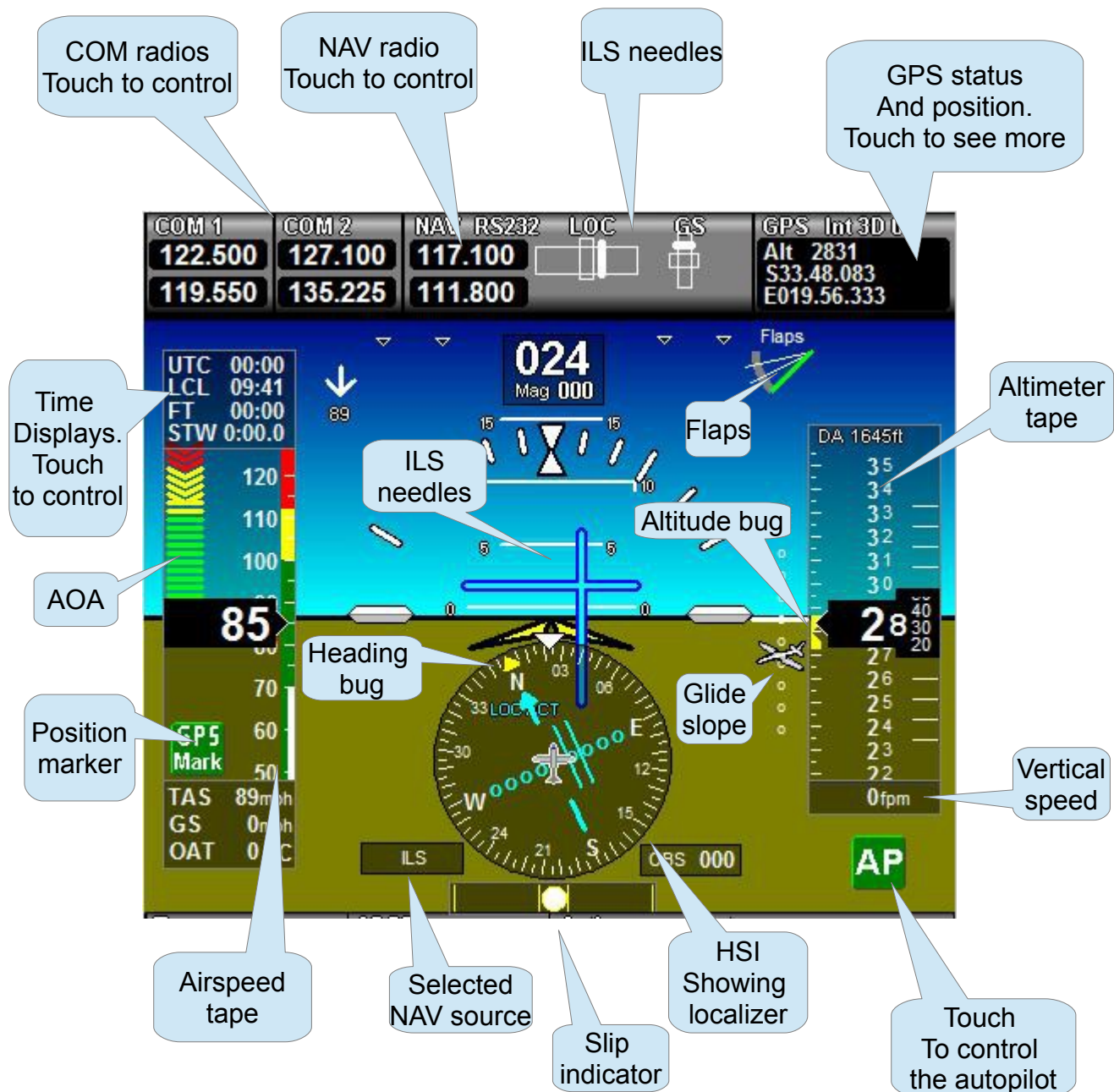

This image shows the built in primary flight display. It might look different if your screen has been customized.

Here the image shows a typical ILS approach. Glide slope and localizer are shown in three different ways: As needles on the NAV status, Needles referred to the yellow flight director reference and finally the HSI and glide slope displays.

This image also shows the flap position. You can configure displays for flap, pitch and roll trim

in the system setup menu.

## Weight and Balance

The Weight and balance function is available under the “Action” menu. It will only show if the required configuration files are present in your panel. There are two files: WB.DAT and WB.MIF. The WB.DAT file contains details about your weight stations and the WB.MIF contains an image of your aircraft (usually top down view). The WB.DAT file is created by the Weight and Balance editor in the iEFIS MX1 Simulator and Screen Designer application. The image file is typically created using a standard image editor on a PC and converted to MIF format using the MGL Avionics MIF converter application.

Note: The aircraft image must be created in the following image size: 500 pixels wide by 300 pixels height. Image format for conversion to MIF must be standard Windows BMP.

The MIF converter is available as free download from the MGL Avionics website (EFIS tools page).

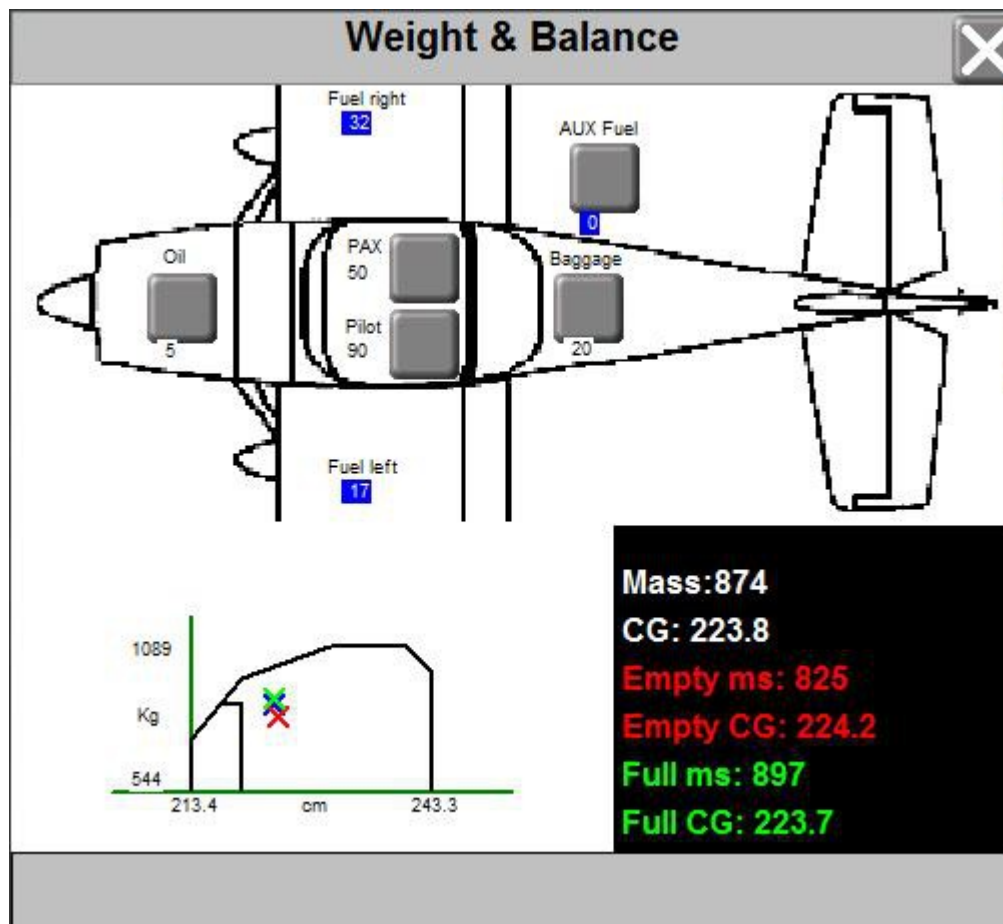

Typical Weight and Balance calculator image. Stations and their functions are selected in the Weight and Balance editor included in the iEFIS Simulator and Screen designer application available from the MGL Avionics website.

## GPS status

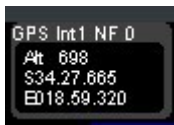

The GPS status shows the fix quality and number of satellites tracked. It shows the current geographic position, GPS derived altitude (if 3D fix is available) and the GPS RAIM status. (the last two indications alternate). GPS RAIM status shows if satellites have been excluded from processing due to integrity concerns.

### The GPS status line:

#### GPS source:

Int - Internal GPS  
NMEA - External NMEA GPS on RS232  
ARINC - External TABS GPS on CAN bus

#### GPS Fix quality

NF - No fix  
DR - Dead recon  
2D - 2D Fix  
3D - 3D fix

This is followed by the number of satellites tracked

#### RAIM information

If RAIM is enabled, the ALT field will alternate between:

ALT GPS altitude if 3D fix

and

Rm RAIM status

RAIM status gives you the current RAIM error limit estimate as follows:

Rm OFF - The RAIM system is not operating. This is usually due to insufficient satellites in view. RAIM requires a minimum of 5 tracked satellites.

Rm H12/V15 - The current RAIM error estimate. It is given in meters. In this example we have a horizontal error estimate of 12 meters and a vertical error estimate of 15 meters. RAIM error estimates tend to be very conservative, the real error is usually much less.

#### RAIM Alert

Should RAIM error limits be exceeded, the entire black inside rectangle of the GPS status display will flash yellow. The limits are setup in the GPS/NMEA setup menu (see installation manual) and also set from any active navigation database SID or STAR procedure.

## GPS status dialog

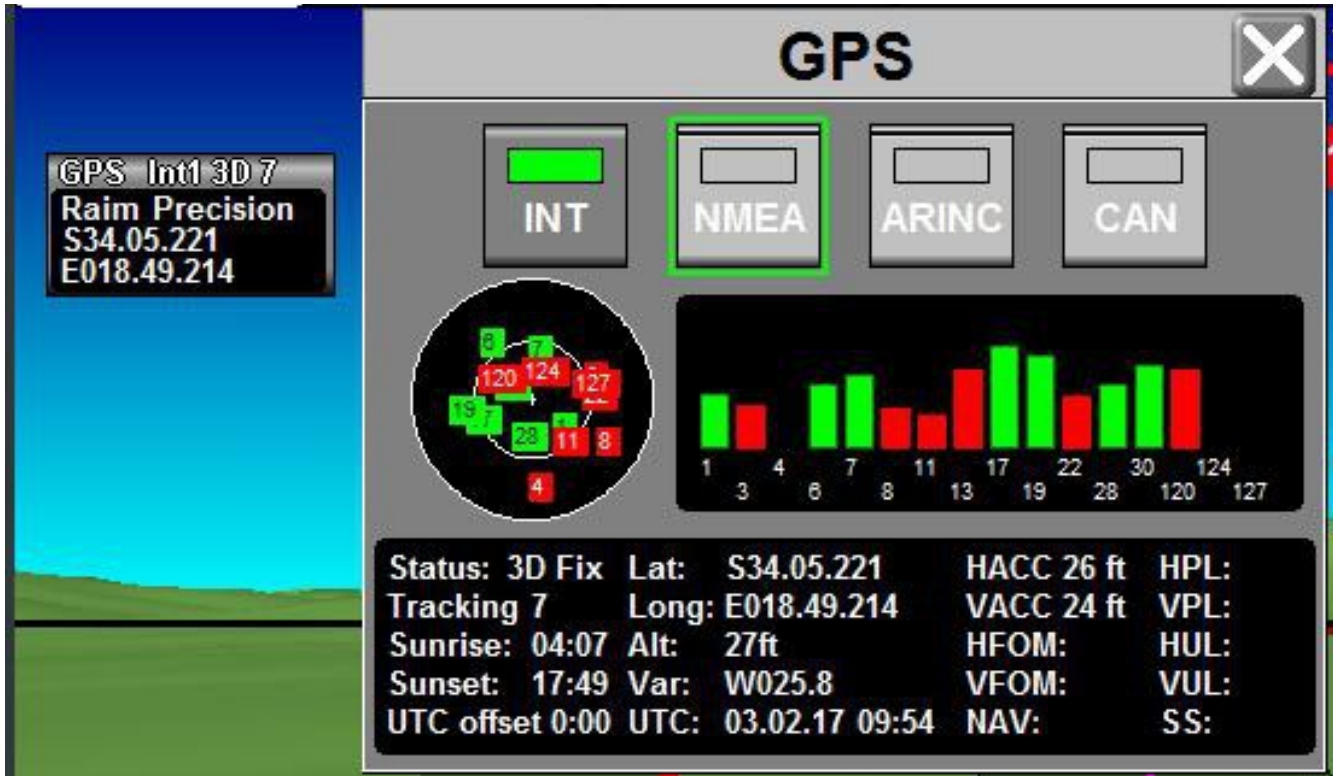

Tapping the GPS status opens the full GPS detail screen. This screen shows a Skyview of the current satellite positions, received satellite signal strengths and several performance and status indicators.

Please consult the separate manual “iEFIS GPS.pdf” available from the MGL Avionics website.

Also consult the manual “ModeS-ADSB.pdf” from the MGL Avionics website which has details on the various GPS sources and how to use them in the ADS-B context.

Note that on the MX1 ARINC based GPS sources are not available.

## COM radios

The COM radio status display shows main and standby frequencies. Tapping on the status opens the Radio control. If you do not have a COM radio connected the status has a grey cross though it (Enable the COM radio in the Equipment Enables menu under System Setup).

A red cross means it is enabled but no information has been received from your radio. Check setup and wiring.





## COM radio dialog

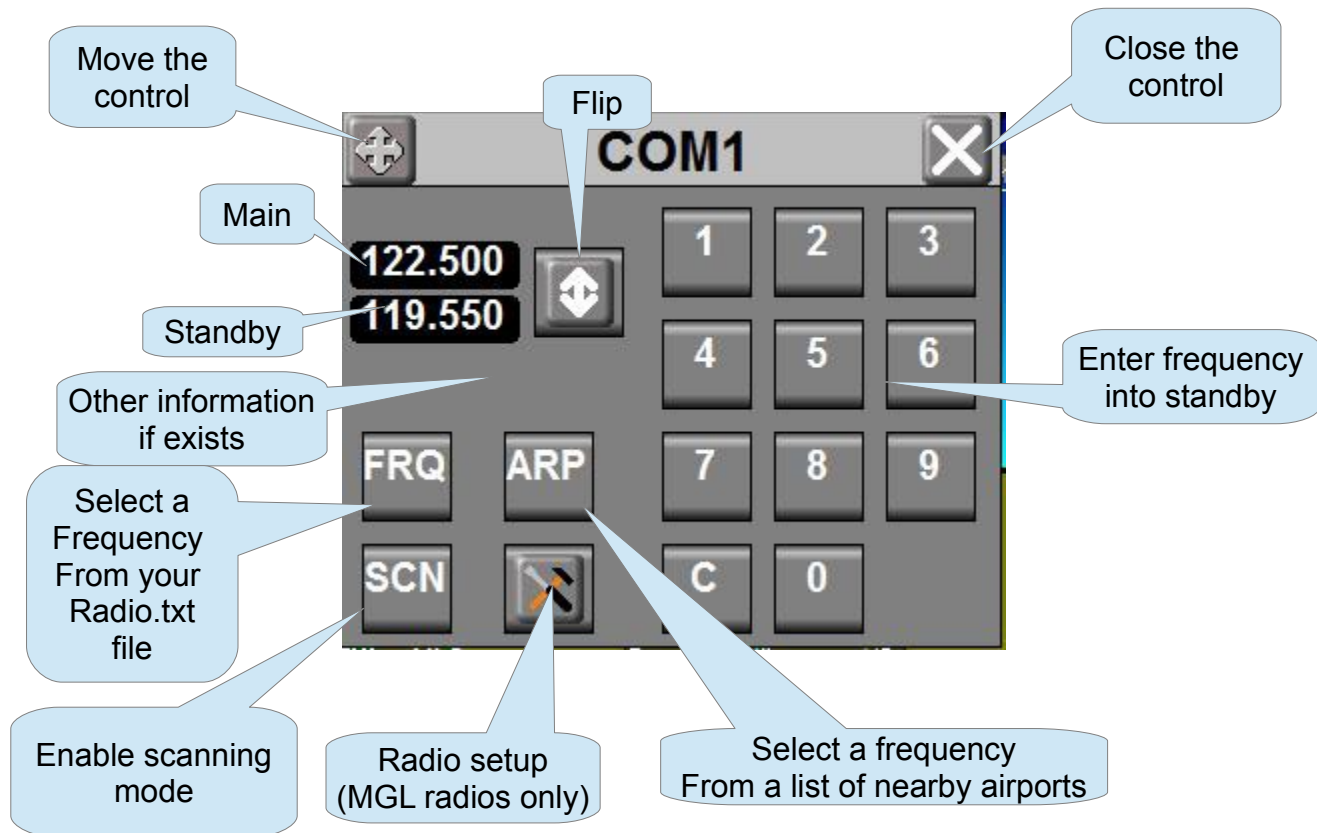

Tapping the frequencies will flip main and standby frequency. Entering frequencies using the numeric keypad requires entering of 6 digits, for example, 123450 will set frequency 123.450 MHZ.

Selecting a frequency from a list: Prepare a list of frequencies in a standard text file format. For example you could use Notepad in Windows. Please create a standard ASCII text file. Native output of word processors cannot be used. You can also create and edit this text file using the built in text file editor in the system setup menu → COM Radio setup.

Here is a sample text file:

;Example frequency list for Radio function

;First entry is frequency in the following formats

;123

;123.0

;123.5

;123.45

;123.425

;This can be followed by a space and then text up to 30 characters for a descriptor

;Lines starting with a ";" are comments (like this line)

124.8 VFR below 1500 AGL

124.4 General flying area

123.45 Chat frequency

120.01 test 1

121.02 test 2

121.03 test 3

121.04 test 4

121.05 test 5

121.06 test 6

121.07 test 7

121.08 test 8

121.09 test 9

;---end of file (this text is not required to be in the file ----

Copy this text file into your panels “Other” folder using the file manager (in the menu) from your SD card..

Tapping the “FRQ” button will then bring up the following dialog:

Select and tap the desired frequency. It will be placed in the standby field.

Note: Frequencies associated with airports or airspaces can be selected directly from the relevant view displays, for example the “nearest airports” display.

The frequency list shown here is mainly intended for often used area or unpublished frequencies. Place frequencies into your Radio.txt file that you use often. In some ways this is equivalent to the channel memory of a radio – just nicer to use.



Note: Tapping the ARP button will allow you to select a frequency from a list of nearest airports. This assumes that the EFIS has a valid GPS position and that your navigation database contains airports with frequency information.

## NAV radio

The NAV radio is based on the capabilities of the connected navigation system. For example, if you have a MGL Avionics N16 or Garmin or similar NAV/COM connected you will be able to use dual VOR navigation or ILS/Glideslope.

Even if you have no NAV radio connected, the NAV radio is still functional. Using the navigation database and the GPS it can emulate a real VOR navigation system. Simply choose the VOR station by selecting the equivalent function from the NAV menu soft key. You can select a VOR station in either the main or standby frequency slot. DME is calculated automatically. You can select VOR stations provided they are defined in your navigation database. Use the GVOR function from the NAV menu.

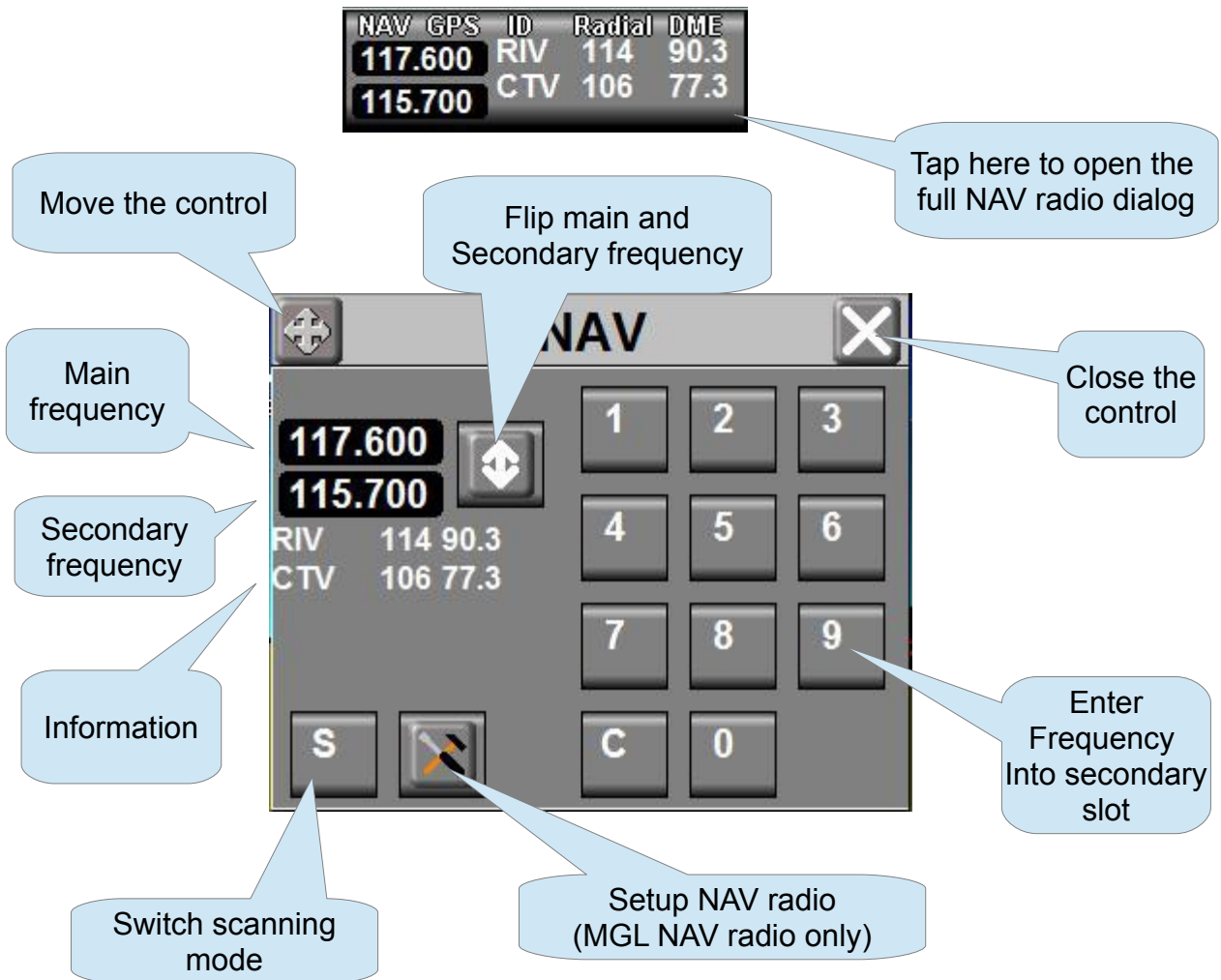

NAV radio in ILS mode. The display switches to ILS mode either by selection of a ILS frequency or by demand from the external NAV radio. It does not switch to ILS mode if a GLS approach is activated as there is little point in that. You can continue VOR navigation even with GLS active.

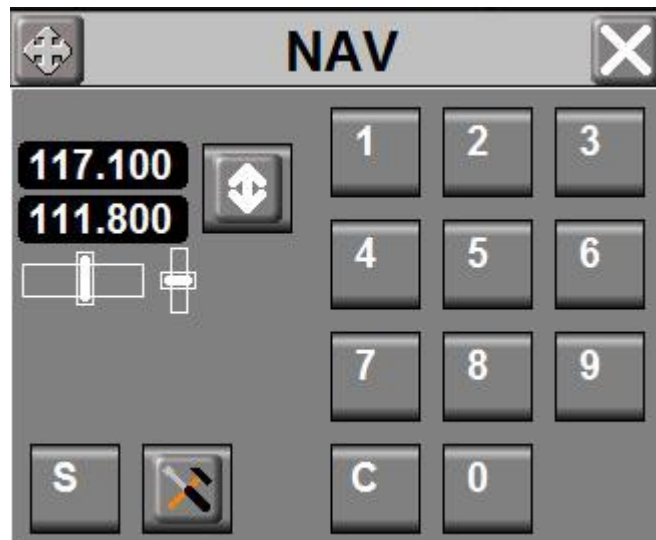

Note: If a NAV radio is connected and navigation is flagged valid, emulated GPS based VOR navigation is automatically suppressed.

You can suppress an external NAV source even if it is active using the “Using external NAV source” function in the NAV menu. Note that this option only shows if an external NAV radio is connected and sending data. If you suppress the external NAV source you may use the internal simulated NAV sources such as GVOR and GLS.

## Transponder



If you have a remote controlled transponder connected to the system, you can tap on the transponder display to open the transponder dialog:

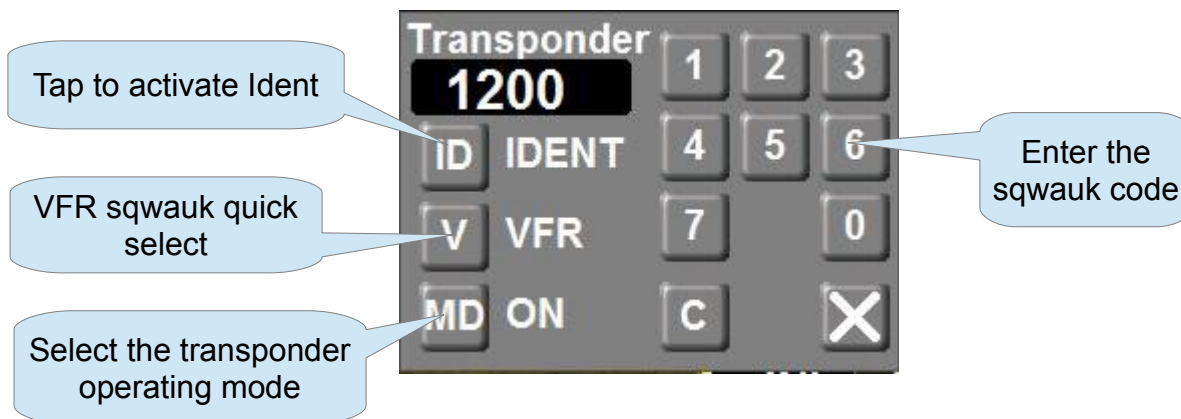

The iEFIS supports the Sandia Aerospace STX165R remote control mode-c transponder connected via a serial RS232 port (assign the port in the serial port setup and routing menu). Also supported is the MGL/Garreht remote, MGL/Trig TT21 and TT22 and MGL T16 mode-s transponder via CAN bus interface. No further interface setup is needed.

Please consult the transponder setup menu:

Setup for mode-c transponder

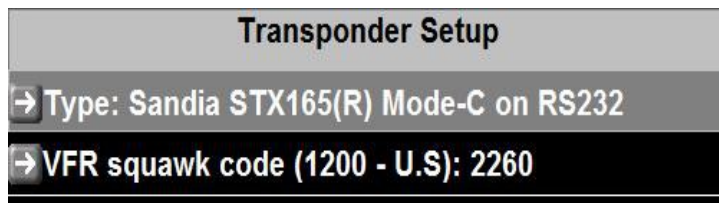

Setup for mode-s transponder

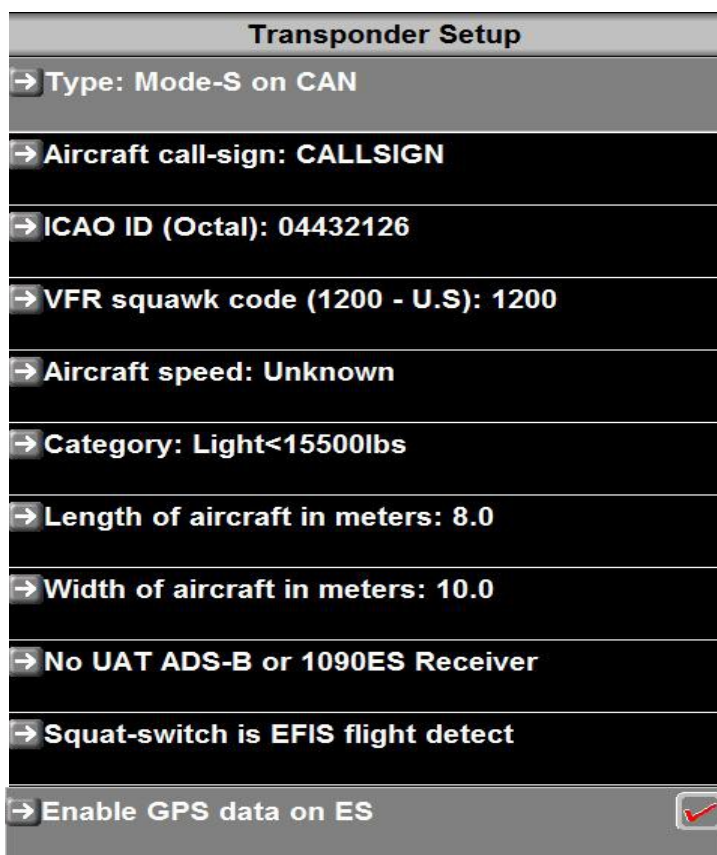

Please enter the relevant information for you aircraft into the transponder setup menu under system setup. Note that the ICAO code assigned to your aircraft is entered in Octal notation. If you have been given your code in Hexadecimal or Decimal notation you can find converters for your ICAO code on the internet.

You have several options for the squat switch – it could be a real switch activated by your undercarriage or a weight sensor, you can choose to have it in flight mode at all times or you can select to use the EFIS flight detect (this you setup in the Operations setup menu – normally you would configure automatic flight detect).

Finally you can disable your transponder from sending GPS information on the extended

squitter (ES). You may want to do this if you have an ADS-B transceiver.

## ADSB

The iEFIS system supports ADSB receivers as well as ADSB transceivers. Currently ADSB systems from NacWorx are supported.

The ADSB status display and dialog is only relevant for ADSB transceivers (“ADSB out”).



Tap on the ADSB status display to open the ADSB dialog.

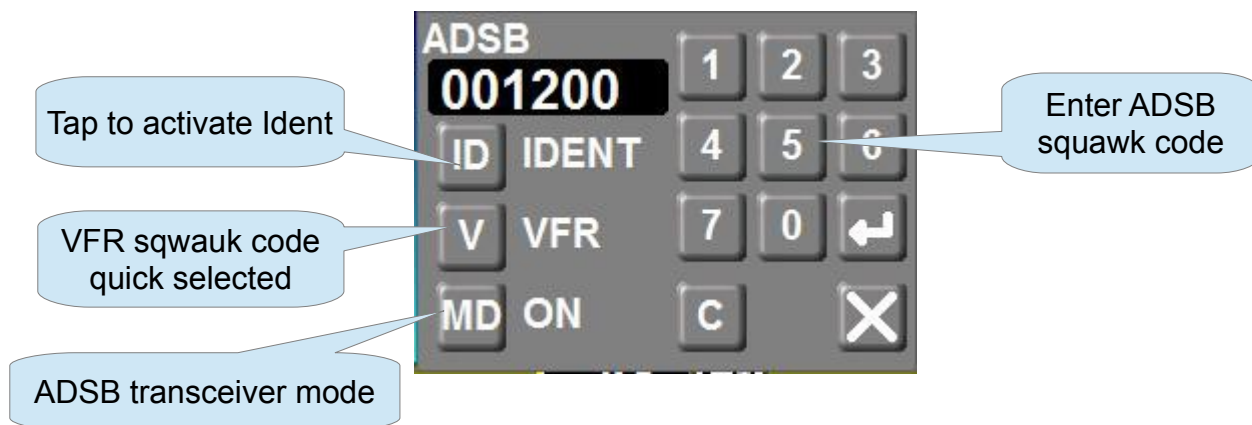

The ADSB transceiver needs to be setup:

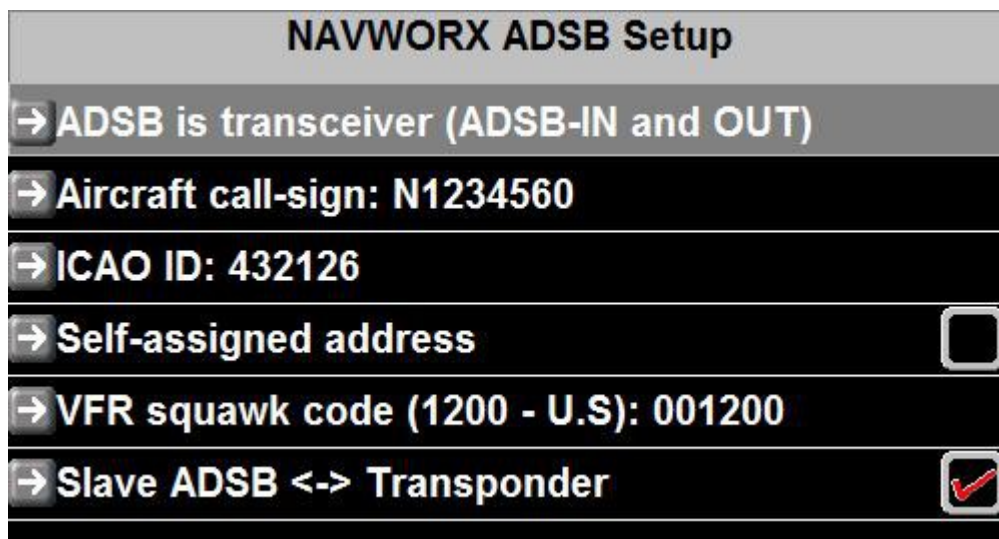

Please note the last item in the ADSB setup menu. This allows you to synchronize the ADSB transceiver with your transponder if you have a remote control transponder connected to your iEFIS system.



If synchronization is activated, transponder and ADSB will transmit the same squawk codes. Ident is also synchronized. You can enter your squawk code in either transponder or ADSB and the other will follow. Note: ADSB has 6 digits. Only 4 are in common use currently.

## Waypoint information

If a GPS waypoint is active, the waypoint information box is visible:



Information available in this display is:

Short and long waypoint names, Estimated time of arrival assuming a great circle line flight to the destination at current ground speed, estimated time en-route. Distance to go and magnetic bearing to destination complete the information.

Tap on the waypoint information display to gain further controls:



This is effectively a larger version of the waypoint status display. You gain a tap function allowing you to cancel the waypoint, get information on the waypoint (which also allows you to select a new one from the nearest airports function) or you can perform a retrack.

Note that you also have a waypoint cancel function available in the Action softkey menu.

## Retracking a waypoint and GPS OBS

This is the procedure allowing you to create a new track from your current position to the waypoint. You would use this if you have deviated from your original track due to an obstacle or other reason but do not want to regain the original track. Effectively this function allows you to draw a new track line from current position to the original waypoint quickly.

Note that there is a related function called "GPS OBS" on one of the rotary controls (if you do not see it press the page rotary control to change the rotary control functions).

GPS OBS is effectively the track angle originating from your waypoint. Using the GPS OBS you can rotate this angle around the waypoint if you wish to approach the waypoint from another direction. The track is shown on your map – zoom the map so you can see your target waypoint and rotate the GPS OBS – note the track line following your input and the HSI is adjusting to the new track instantly.

## GPS mark position



You can mark the current position at any time. Tap the GPS mark position and you will be presented with a waypoint editor:

A screenshot of a mobile application dialog box titled "Waypoint editor". The dialog has a dark red background and a grey header with a close button (X). The content is as follows:

→	Waypoint type:	WAYPOINT
→	Short name:	WPT
→	Long name:	Waypoint
→	Latitude:	S29.59.633
→	Longitude:	E019.03.601
→	Altitude:	4855
→	Save to:	Markers.ERT route
→	Accept this waypoint	
→	Cancel	

Here you may edit the newly created waypoint. You may want to give it a name. Finally select where you would like to save the waypoint to. You may choose the “markers” route file or you can save your waypoint to the supplementary waypoint database.

Starting with an empty “markers” route file you can easily create a route “on the fly”.

Waypoints stored in routes may be reused in new routes.



## Flight plans

Flight Plans are managed via the FPLAN button.



If no flight plan is current active you will be taken to the Flight Plan manager. If a Flightplan is active you will see the active Flightplan popup. If the Flightplan popup is showing tapping the FPLAN button will hide the Flightplan (it remains active).

If the Flightplan is active, tapping the FPLAN button twice quickly will get you to the Flightplan manager.

### *The Flightplan manager*

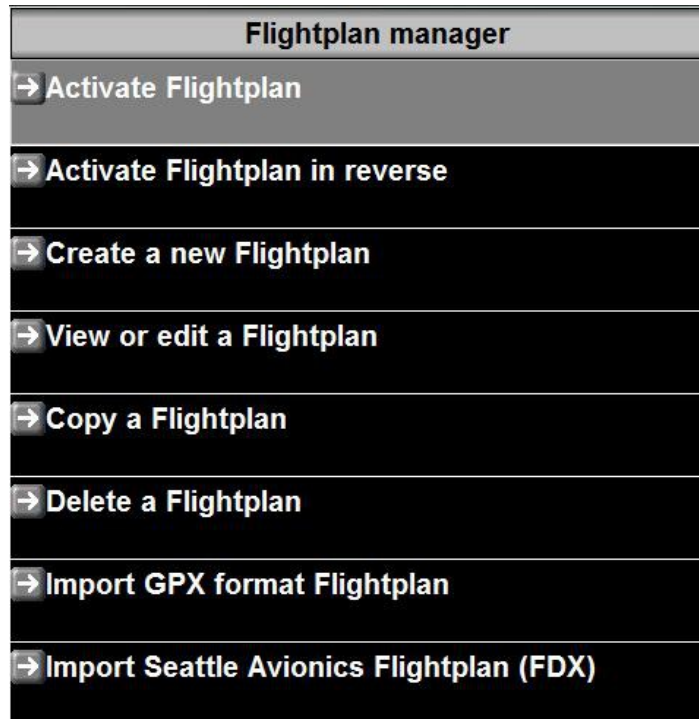

Flight plans are a collection of waypoints to be reached in order. You can create flight plans on your EFIS using the Flight planning tool or import Flight plans created by other applications. In the latter case you will copy them to the external SD Micro card and activate them from there. Note that if you activate an external Flight plan it will be copied to your internal disk and placed in the FlightPlan folder. If you import a Flight plan in GPX or FDX format it will be converted into MGL format "ERT".

Flight plans are files with a name that usually describes the flight plan. Note that you should not use names longer than 30 characters (plus the file extension) with the MX1 – it will truncate longer names for brevity.

Once you have activated an external flight plan you can reuse it from internal disk storage.

### **Activate Flightplan, Activate Flightplan in reverse**

These two functions are very similar. You will be asked where to look for the flight plan – your choices are:

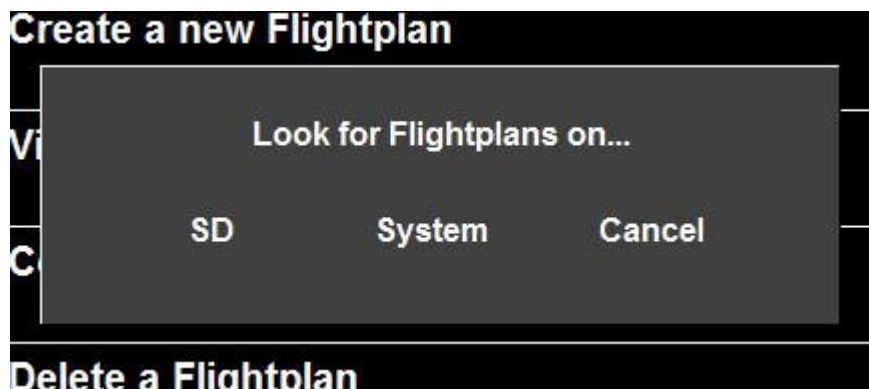

Choose “System” if your flight plan is on the internal disk (used before or created on your system). “SD” looks for the flight plan on your external disk.

Once you have selected your flight plan it is activated immediately at the first (or last) waypoint depending on which direction you would like to fly the flight plan. In most cases you would select to fly it in the defined direction so choose “Activate Flightplan”.

### **Create a new Flightplan**

Choose this to create a new flight plan. You will be asked for the name of the new flight plan. Choose a name that contains permitted file name characters. You do not enter the file extension. That will be added by the system automatically. For example a name to enter could be:

Once you have entered your name you will be taken to the Flightplan tool.



### ***View or Edit a Flightplan***

You will be presented with a menu allowing you to choose a flightplan from your internal disk storage (The Flightplan folder you can also access via the built in file manager).

Once you selected your flight plan it will be loaded and you will be taken to the flight plan tool where you can view and edit the flight plan.

### ***Copy a Flightplan***

Choose a flight plan – you will then be asked for a new name. A new, identical flight plan will be created. Use this function if you have a flight plan on your system that is similar to the one you need. It can be much quicker to edit a similar flight plan than to create a new one in particular if it contains many waypoints.

### ***Delete a Flightplan***

Once you know you no longer need a flight plan you should delete it from the internal disk.

### ***Import GPX format Flightplan***

Many third party flight planning tools can export flight plans in the GPX file format. You can import these files and convert them to ERT format.

Note that the success of this varies between sources of your GPX file. The MX1 will attempt to extract a short and a long name for each waypoint in the file as that is the internal for at used (the short name is usually the ICAO code and the long name something descriptive). GPX does not define this well so there is a bit of variation in the available GPX files.

### ***Import Seattle Avionics Flightplan (FDX)***

Seattle Avionics flight planning tool exports in its own format that you can use here.

### ***Canceling an active flight plan.***

If a flight plan is active in your system there are three ways to cancel (deactivate) it:

- 1) A Flightplan cancel function will appear in the “ACTION” menu (tap the ACTION button).
- 2) A Flightplan cancel button will be available in the Waypoint status.
- 3) You can cancel the flight plan in the Flightplan manager. Tap the FPAN button twice (with the flight plan popup not showing) to show the Flightplan manager. The Flightplan manager will offer a cancel function in addition to the functions shown above).

## The Flightplan popup

The Flightplan popup shows if you tap the FPLAN button while a flight plan is active. To hide the Flightplan simply tap the FPLAN again. If you tap the FPLAN twice rapidly (within a second) and the flight plan popup is not showing you will be taken to the Flightplan manager.

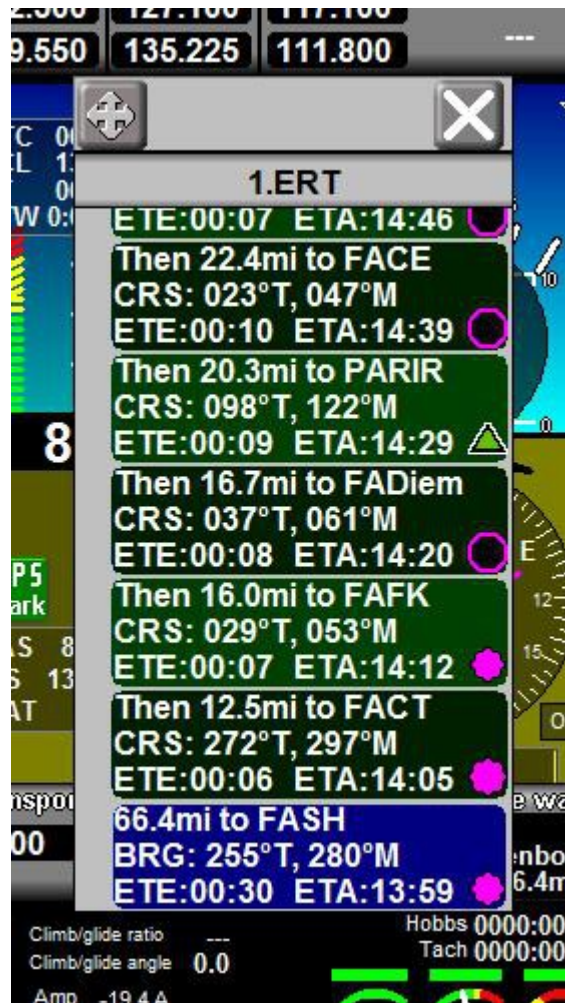

The Flightplan popup shows the next and previous waypoints of the active flight plan in bottom to top order (i.e. you fly towards the waypoint that is higher in the list).

The current waypoint is shown with a BLUE background.

You will be shown information on:

Distance to the current waypoint (this will decrease as you get closer). Distances between each of the following waypoints. You will also be shown the course to fly in both true and magnetic notation. You will be shown time to and between waypoints as well as arrival time at

each waypoint based on your current ground speed from your GPS.

If you tap on any of the waypoints in the list you will select that waypoint for further action (if any). The waypoint selected will have a PURPLE background. At the same time the context of the touch fields at the bottom of the display changes:



This will remain for a short while before reverting back to the normal display.

One of the Rotary controls now allows you to move the selected waypoint. It will also scroll the list if it is longer than space on the screen. You can also use the NextWP and PrevWP buttons if you prefer.

GOTOWP will activate the currently selected waypoint as the next waypoint.

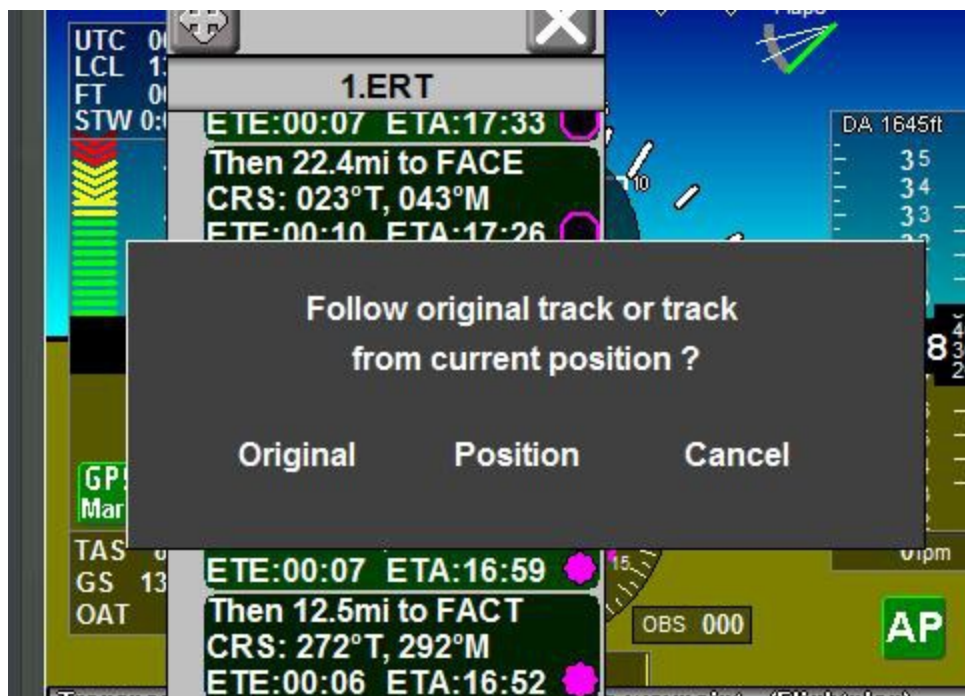

If you perform a GOTOWP the MX1 will ask you if you would like to follow the original track to the new waypoint selection or if you would like to create a new track from your current position.

ENDFP is another function available to cancel the active flight plan.



INFO will show available information for the selected waypoint such as frequencies or other information as defined in your navigation database.

Example:



FUEL changes the popup into Fuel consumption mode:

Assuming you have a fuel flow sender installed and configured the MX1 will calculate the fuel needs for every leg in your flight plan and also give you required fuel totals. This is a live display so you can easily see how power setting changes affect your fuel needs to arrive at a particular waypoint. Tapping FUEL again will revert to the normal popup display.

FLIP will mirror the active flight plan at the current position. The last waypoint will become the next waypoint. You have reversed the flight plan. This is a quick way to head back where you came from.

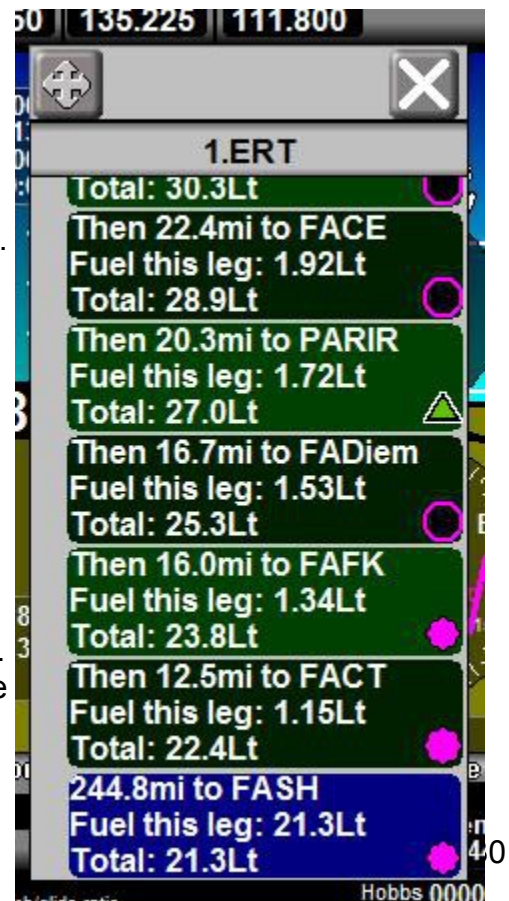

MANAGE will lead you to the flight plan manager.

### ***Waypoints behind are not forgotten***

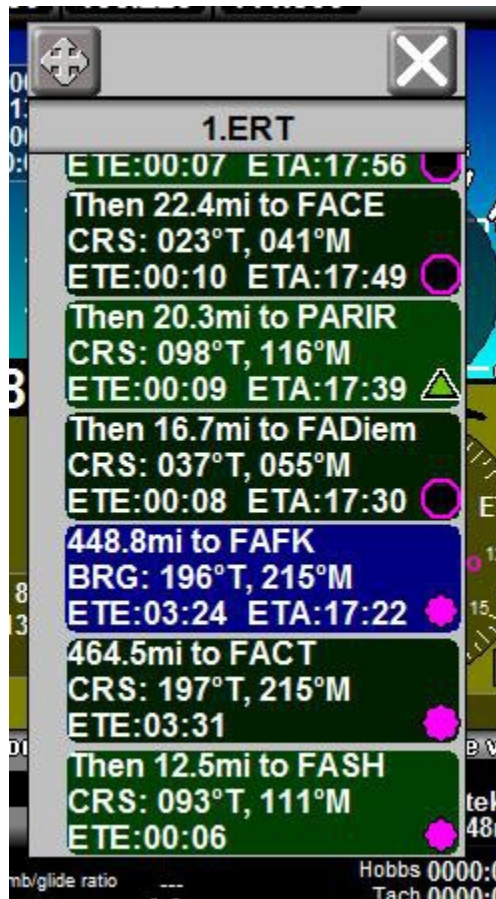

Here you can see an example of waypoints that are behind you. The current waypoint here is FAFK and we still have a few minutes to go.

At the same time we can see the last waypoints we passed and also see distances and course information should we need to return.

Use the FLIP button to reverse the flightplan at your current position so you will now be flying towards the last waypoint that is now the next waypoint.

## The menu system

Press the “Menu” button to activate the menu system.





## ***Supplementary Waypoint editor***

Please consult the MGL EFIS files document for detailed information on the various files and their uses in the iEFIS system.

The supplementary waypoint file is used to hold user created waypoints. Here you can create waypoints that the system can use in addition to those provided in the navidata file(s).

## ***Primary Navidata waypoint viewer***

The primary navidata file contains navigation data provided either by a third party such as Jeppesen or you can also create and maintain your own navidata file using the MGL Central application.

The system permits up to 26 primary navidata files. One is active at any one time. You select the currently active navidata file using the NAV soft key. Navidata files are identified by the last character of the file name. This may be a character from a-z. The last navidata file would have the full filename of navidatz.ewd

Waypoints in the navidata file can be viewed but not edited.

## ***Secondary Navidata waypoint viewer***

The secondary navidata file contains navigation created using the MGL Central application.

This allows you to use a subscription product such as Jeppesen while still allowing use of a custom database that you can create yourself. One reason you may want to do this is to add airports with runway information that are not included in your subscription product.

The filenames used are Snavi.ewd or SnaviA to SnaviZ.ewd

The system permits up to 26 secondary navidata files. One is active at any one time. You select the currently active navidata file using the NAV soft key. Navidata files are identified by the last character of the file name. This may be a character from a-z. The last navidata file would have the full filename of SNaviz.ewd

Waypoints in the navidata file can be viewed but not edited.

Secondary navidata files are exactly the same format as primary navidata files. Only the filename changes.

Note: Subscription products cannot be secondary navidata files, they can only be used as primary navidata files.

## ***Information system menu***

Obtain information such as serial numbers or view the system log.

## ***Common Tasks***

A collection of a few tasks such as exporting the flight log

## ***Install Tasks***

This is a collection of automated installation functions you can choose to copy data files to the system such as map and terrain files.

## ***System setup menu***

This is the entry point to a comprehensive system setup menu.

This is described in detail in the iEFIS installation documentation.

## ***3D View setup***

A collection of setups affecting your primary flight display. Here you can select various heading tapes, flight director functionality and other setups related to how things are displayed on your horizon display.

## ***File manager***

The file manager gives access on the file and folder level to internal files. You can copy files between internal disk and SD card or delete files.

Please ensure that you are familiar with the function and location of all files before using this function. This is powerful in the hands of the experienced user but you may also destroy your system by performing file operations that will cause a system malfunction.

## ***Engine and airframe timers***

Here you can access all enabled timers related to your engine such as Hobbs, Tach and maintenance timers as well as the airframe timer.

This display is “read only”. You can edit the timer values in the setup menu under Time/Date/Hobbs setup.

## ***Daylight backlight setting***

Select the desired level of the back light for daylight operation. This is most likely the maximum setting of 31. Select a lower number if your system operates from battery and you need to conserve power. A setting of 24 reduces the systems power consumption by about 1/3.

Note: You switch between day and night light settings using the “Action” soft key.

## ***Nighttime backlight setting***

Select the desired backlight setting for night time operation. Most likely you will choose a very low number.

Note: You switch between day and night light settings using the “Action” soft key.

## ***System Diagnostics***

This menu provides a host of useful diagnostics functions for the system and connected devices.

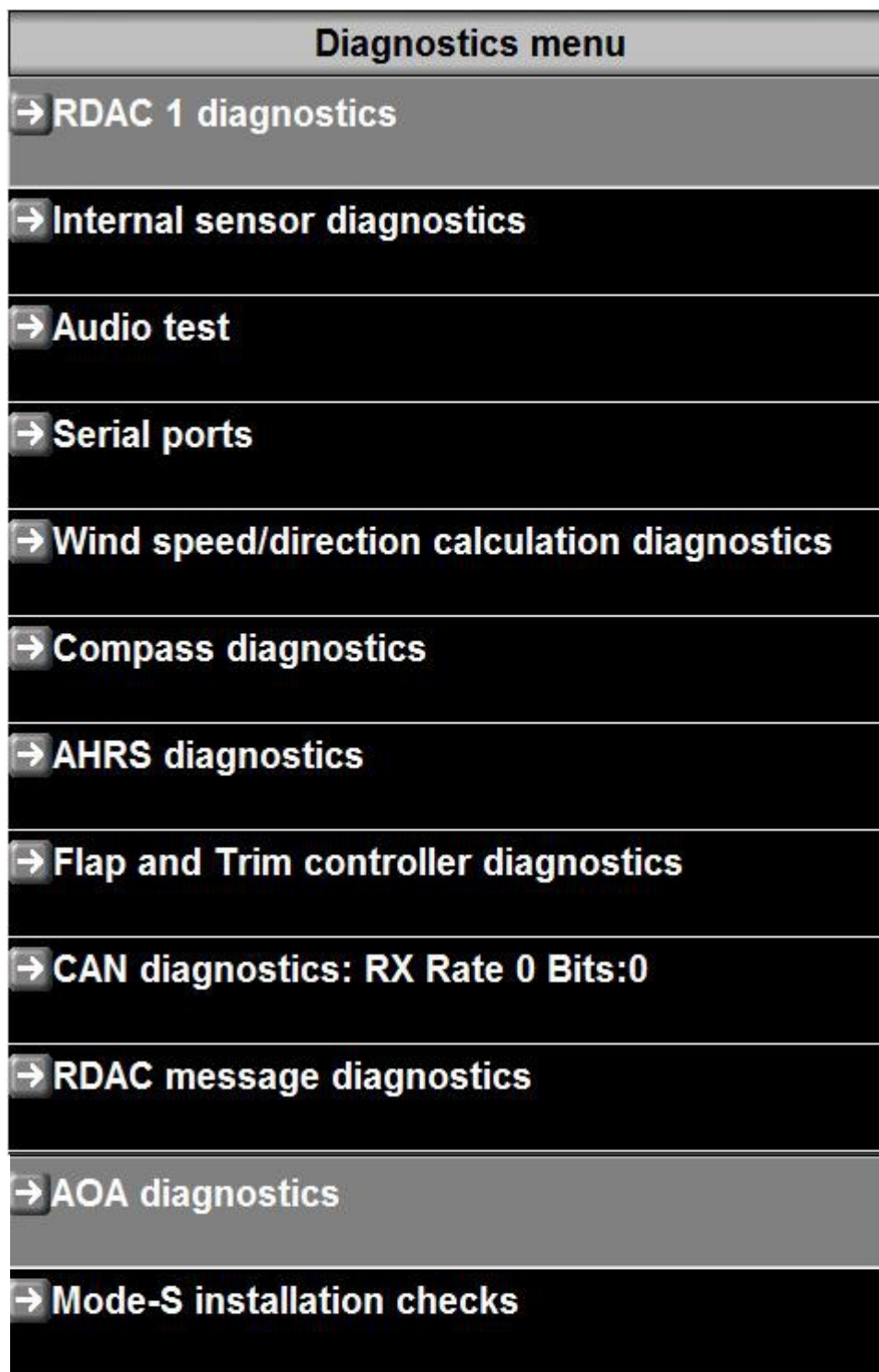

# The Flightplan Tool

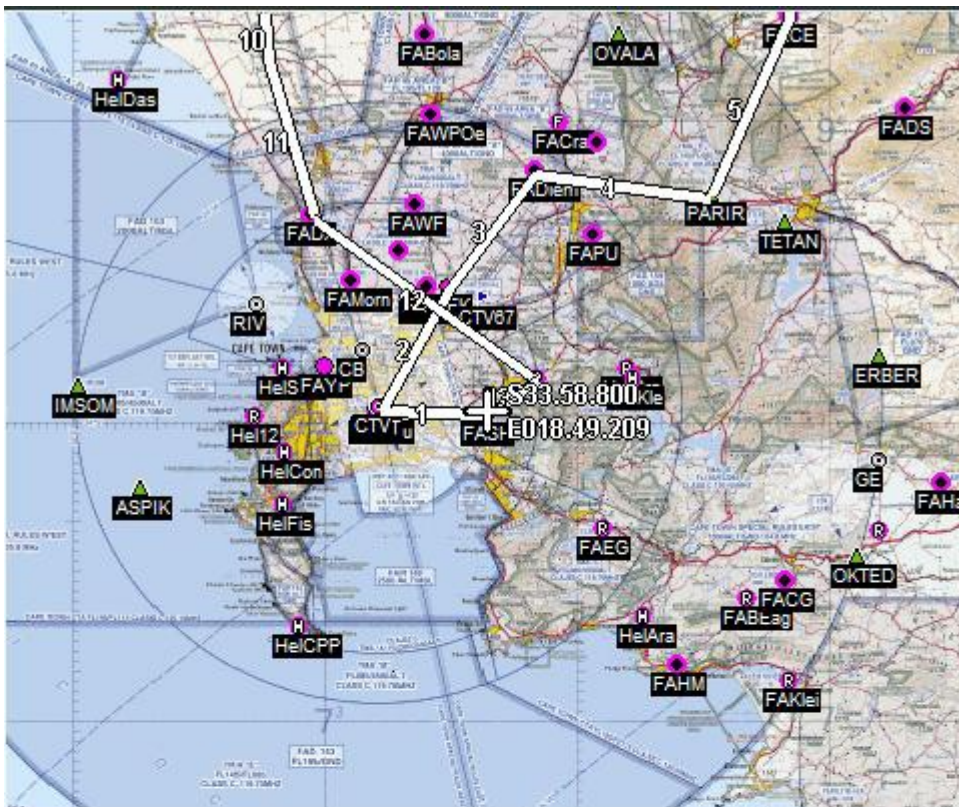

The Flight plan tool starts with the option of creating a new route or editing an existing route using the FPLAN button from any page display.

Move (PAN) the map by tapping on the location you want the map to be centered at the cross hairs. Use the rotary control to zoom the map scale.

Tapping on a waypoint in the list centers the map at that waypoint and also selects that waypoint for edit, deletion or adding a new waypoint after.

The map draws the Flightplan tracks in white and each leg is numbered.

Tap EXIT to leave the flightplan tool without changing the flightplan or tap "SAVE AND EXIT" to save your changes.

Exit	↑ 1.ERT ↓		
Save and close	1	FASH Stellenbosch	
ADD waypoint	12.5mi	BRG: 272.8°T 296.9°M	to FACT
Edit waypoint	2	FACT Cape Town Intl.	
Delete waypoint	16.0mi	BRG: 29.4°T 53.5°M	to FAFK
Latitude	3	FAFK Fisantekraal	
Longitude	16.7mi	BRG: 37.2°T 61.2°M	to FADiem
Center at GPS pos	4	FADiem Diemerskraal	
Map options	20.3mi	BRG: 98.1°T 121.9°M	to PARIR
Longitude	5	PARIR PARIR,SOUTH AFRICA	
Latitude	22.4mi	BRG: 23.8°T 47.5°M	to FACE
WP: Up/Down	6	FACE Ceres	
Zoom map	15.2mi	BRG: 6.1°T 29.8°M	to FAZZ2L
	7	FAZZ2L ZZ2 Loohlyne	
	26.6mi	BRG: 280.8°T 304.4°M	to FAPort
	8	FAPort Porterville	
	28.3mi	BRG: 0.8°T 24.2°M	to FACI

Flight plans are stored in your internal drive in the folder “Fplan”. Flight plans files can be copied using the file manager. You can also use the “Flightplan manager” and seldom will need to access these files directly.

Once a route is open the right hand pane shows the route details. You can navigate the Flight plan using the touch screen.

### ***ADD Waypoint***

Adding a waypoint to a Flightplan is the function used most often. Waypoints are always added following the highlighted waypoint in the list (white background) or as first waypoint if the list is empty. You will be presented with a list of options:

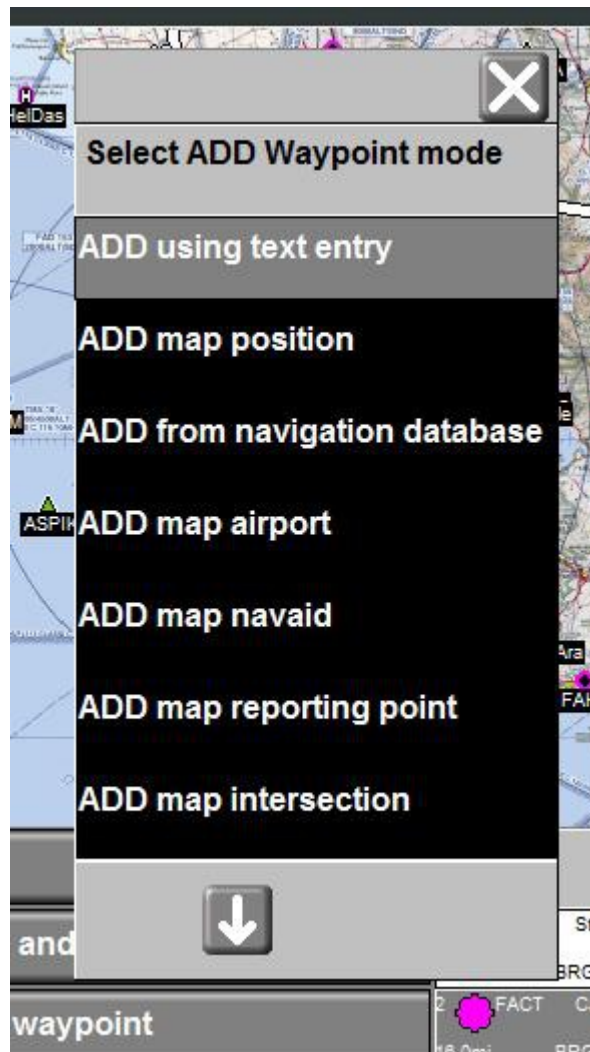

### **Add using Text entry**

Here you can add one or more waypoints using common ICAO text entry format.

"KLAX 503010N08923W" as entry would define two waypoints. KLAX (Los Angeles International) to a point at N50:30:10 W89:23:00. You can enter multiple points on one line, up to 250 characters at a time.

If you use an identifier (such as KLAX) and this cannot be found in any database (including your supplementary database) the import stops at that item with a message. In that case either correct the identifier if you had it wrong or try using coordinates or simply pick the location directly from the map.

As it is possible that identical identifiers are used for multiple items - if this is the case you will be presented with all of the ones found with additional information to help you choose the one you desire.

### **Add map position**

This adds the center of the map at the cross hairs as waypoint. it will create a general waypoint at that location (you can always edit the waypoint details and add something descriptive).

Note that moving (panning) the map is done using single finger taps – tap the map location that you would like to center at the cross hairs. To move large distances zoom the map to a greater area.

### **Add from navigation database**

This opens your navigation database waypoint viewer where you can select a waypoint (consider using the search function).

### **Add map Airport, Navaid, reporting point, etc**

This operates similar to “Add Map position” except the system will search your database for the requested waypoint type that is closest to the cross hairs (locate the map so the desired waypoint is close to the cross hairs).

### ***Edit and Delete waypoint***

These two functions allow you to edit the details of the selected waypoint (waypoint with a white background in the list) or you can remove that waypoint from the list.

### ***Latitude and Longitude***

Here you can enter the latitude and longitude using numeric entry – this is the position you would like to place the cross hairs. You can also change latitude and longitude using the rotary controls.

### ***Center map at GPS pos***

Place the cross hairs at your current position as reported by your GPS.



## Map options

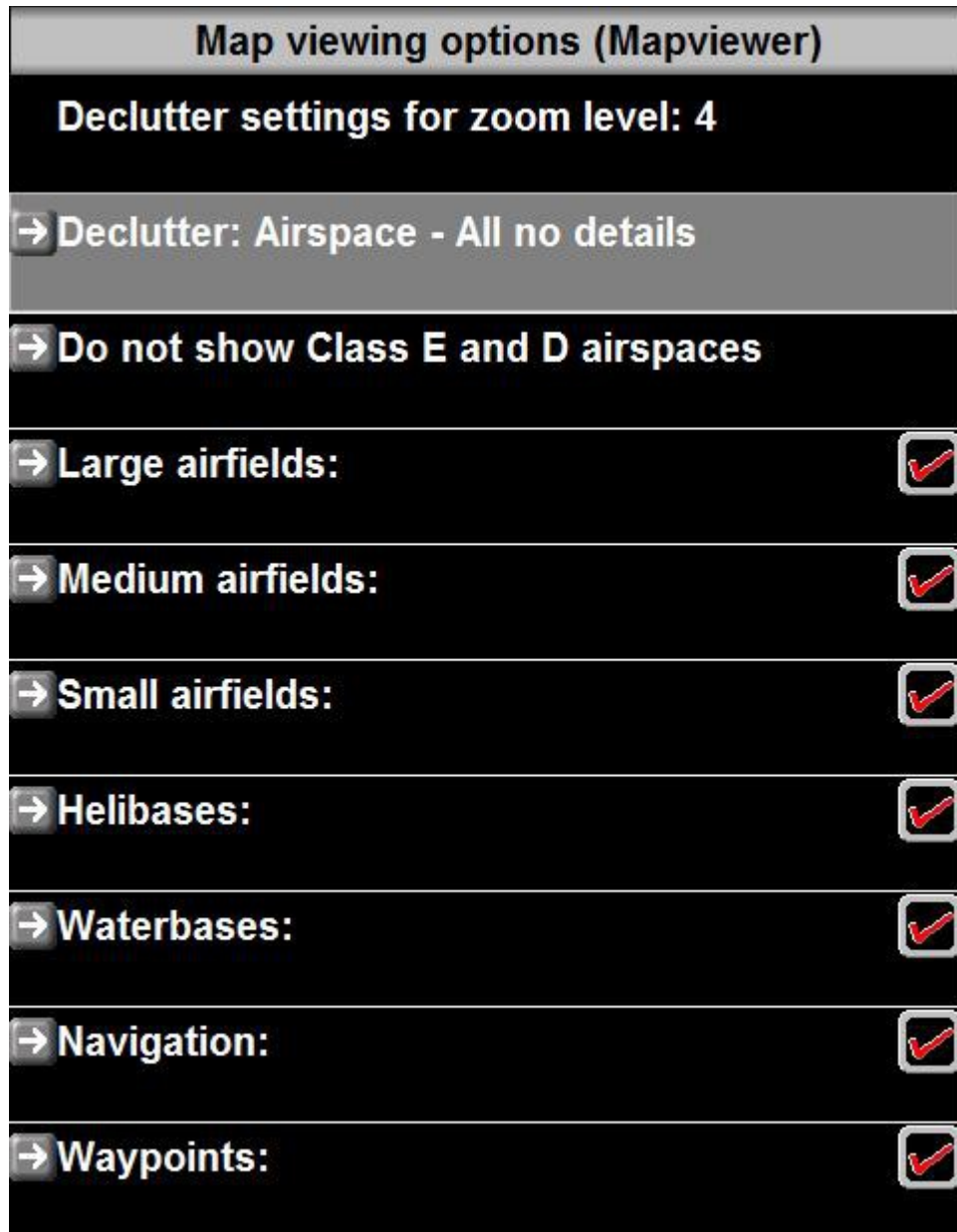

Here you select which navigation database waypoints to display as well as airspace types. Note that every zoom level has its own settings. Select the zoom level you would like to change before tapping the Map Options button.

# Working with maps

Typical map view – here we have a “track up” display

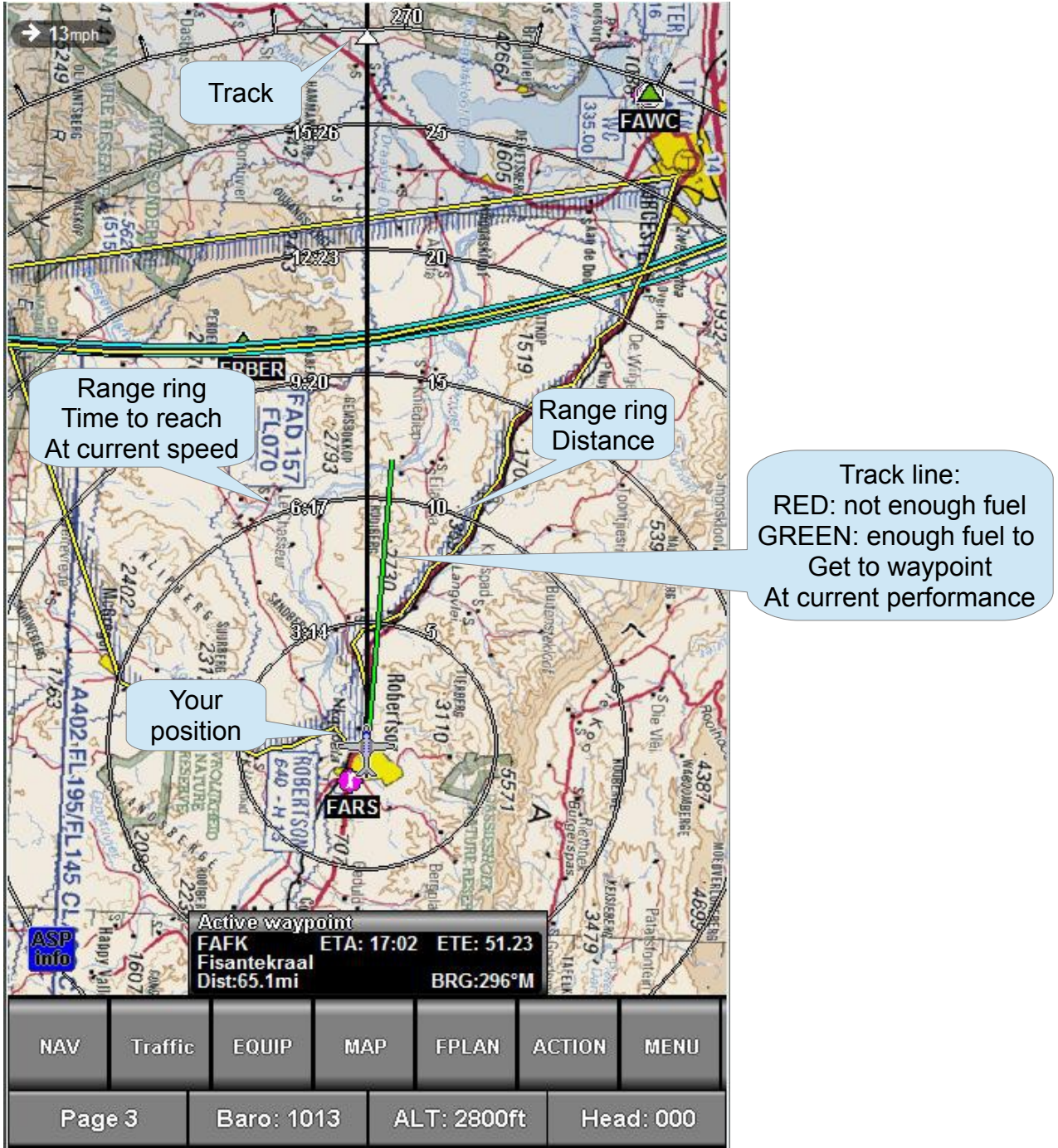



Tap on the map and you get:



### **Mode**

Allows you to select the map in either track up or north up modes.

You can also select from several different installed map styles if you have more than one style installed.

Note: Every page that has a map maintains its own settings and these are remembered if the system is switched off.

### **Airprt**

Tap on an airport symbol on the map, then select Airprt to see information about the airport from your navigation database such as runway information or frequencies.

### **AirSP**

Tap on the map at any location and then select AirSP. You will get a list of all airspace relevant for that location:

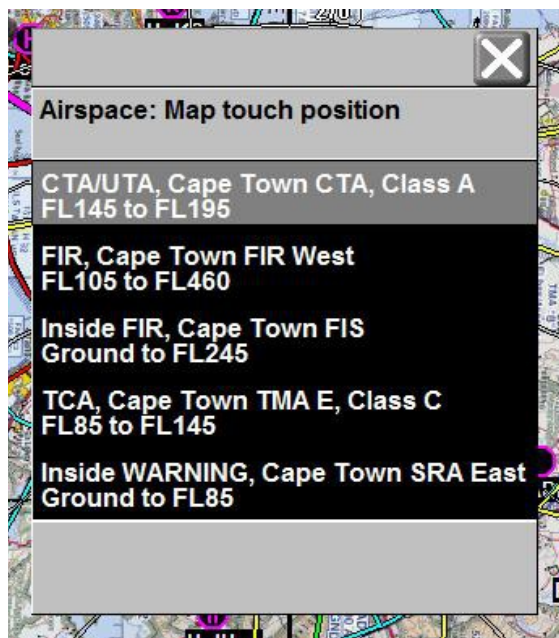

## Divert

This function allows you to define a multipoint divert and even create a flight plan from your entries. You need to have an active waypoint. This has a track leading to it. You can add up to 20 points anywhere on the map and reshape the track to follow your divert. You can also save your divert as a new Flightplan.

In Divert mode the soft buttons change to this:

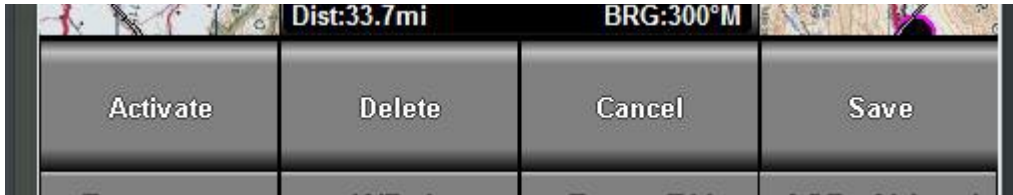

Here we tapped on two locations on the map to define our divert.

The original track is still shown in magenta color and the divert track is shown in blue.

We can use the Delete function to remove the last point entered (this continues until no more points are left).

If you change your mind select Cancel.

You can now save your divert as a new flightplan. You will be asked for a name for the flightplan.

If you are happy with your divert and want to execute it – select Activate.



This is what it looks like after we activated our Divert. In effect it has created a flight plan with three waypoints – we created two along the Divert and the third one is our original waypoint.

With the Divert now active, tapping on the map gets us:



Note that a DivEnd button has been added. This allows us to end the divert at any time. The original waypoint will be restored as active waypoint.

### **Retrack**

This function is identical to the retrack function in the waypoint status. This allows you to create a new track from your current position to the active waypoint.

### **PAN**

This function puts the map in PAN mode. In PAN mode the map is no longer centered at your current position. In PAN mode you touch the map anywhere and it will be centered at that position. Note that during PAN mode the map is always north-up.

PAN mode allows you to locate the map anywhere.



# Map information mode

Tapping on the map twice from normal soft key mode gets you:

The screenshot displays a map with a flight path highlighted in yellow and green. A vertical line indicates a heading of 270 degrees. A speed indicator at the top left shows 13mph. A distance callout shows 16.4 mi and 12Min. A box in the center identifies the location as Cape Town, RA East, FLB. A detailed data box at the bottom provides the following information:

Active waypoint		
FAFK	ETA: 17:03	ETE: 40.53
Fisantekraal		
Dist: 51.8mi		BRG: 297°M

Below the data box is a control panel with two rows of buttons:

Airport	Airspace	Goto	MakeWP	Clear
Zoom map	WP: L	Base: BU	ASP: ALL-nd	

In this mode tapping any location on the map does two things:

A yellow line shows the track between the current aircraft position and the point you touched on the map. A grey popup at the touch location shows the distance to that point and how long it would take you to get there at current ground speed.

Secondly – if your touch is within an airspace boundary – the boundary is highlighted and a further popup appears giving you details of this airspace such as name and levels.

Should more than one airspace be applicable to the location then the airspace occupying the smallest area is selected.

Note the soft key buttons are in a new mode:

### ***Airport***

Touch an airport symbol on the map (symbol from database) and then touch the Airport button. The MX1 will search the navigation database for this airport and enter the airport information display for this airport.

This allows you to view relevant airport information for this airport and also activate GLS approaches to runways (if defined).

If there is no further information available for the airport then a message will be shown. This typically happens if a waypoint has been defined as a an airport type but there is no related airport data in the database.

### ***Airspace***

Shows all the airspace information relevant for your current position.

### ***Goto***

This useful button allows you to touch any point on the map and then select “GOTO” this creates a waypoint at the touch location and activates GPS navigation to that point.

Try this with the autopilot engaged. It's fun.

### ***MakeWP***

The last location touched on the map becomes a new waypoint and this is stored in your supplementary waypoint file (The file is called Waypoint.ewd and is located in your internal disks Navdata folder.

Before the waypoint is inserted you have the opportunity to fill in details such as waypoint types and name.

### ***Clear***

Exits out of the map information display and returns to normal mode (you can also just let it

time out – it will return to normal mode after a few seconds).

## Panning the map

Sometimes it is required to view the map in locations that are not visible on the screen.

Most touch screen devices like your mobile phone allow dragging of maps with your finger. In a cockpit environment with typical mounting positions of an EFIS system this does not work well. The MX1's touch control is thus designed to perform actions using single finger touches which are much easier to do in an aircraft in particular if there is turbulence.

**In PAN mode the map is always in “North-Up” mode. The map center is shown as a cross hair and the latitude and longitude of that location is displayed.**

**Simply touch the location on the map in pan mode that you would like to have centered at the cross hairs.**

**To move a large distance first zoom the map to a larger scale.**

In the preceding chapters you will have noticed many ways to use the map using single touches.

To move the map you need to select “PAN” mode.

From normal mode touch the map anywhere and then touch the “PAN” button.

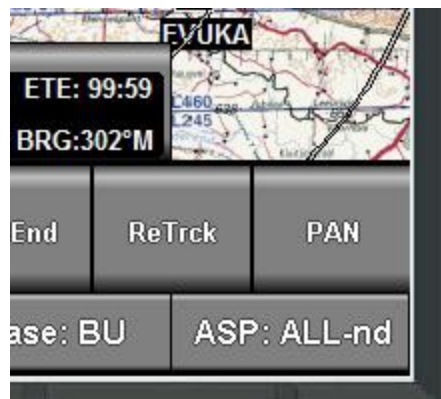

This places the map in “PAN” mode and the soft buttons change to:



Airprt, AirSP, Divert and Retrack work as described earlier.



### ***P-off***

Switch off PAN mode and revert to normal map mode with the map location centered at current position.

### ***P-hold***

This suspends PAN mode at the current PAN location allowing you to touch the map without moving it. In PAN hold mode all the normal map touch functions work such as obtaining information on airspaces, distances and time to a map point as well as activating a GOTO.

When you are in PAN hold mode, the soft key buttons are:



### ***P-go***

This resumes Panning mode.

# Map Display in Panning mode

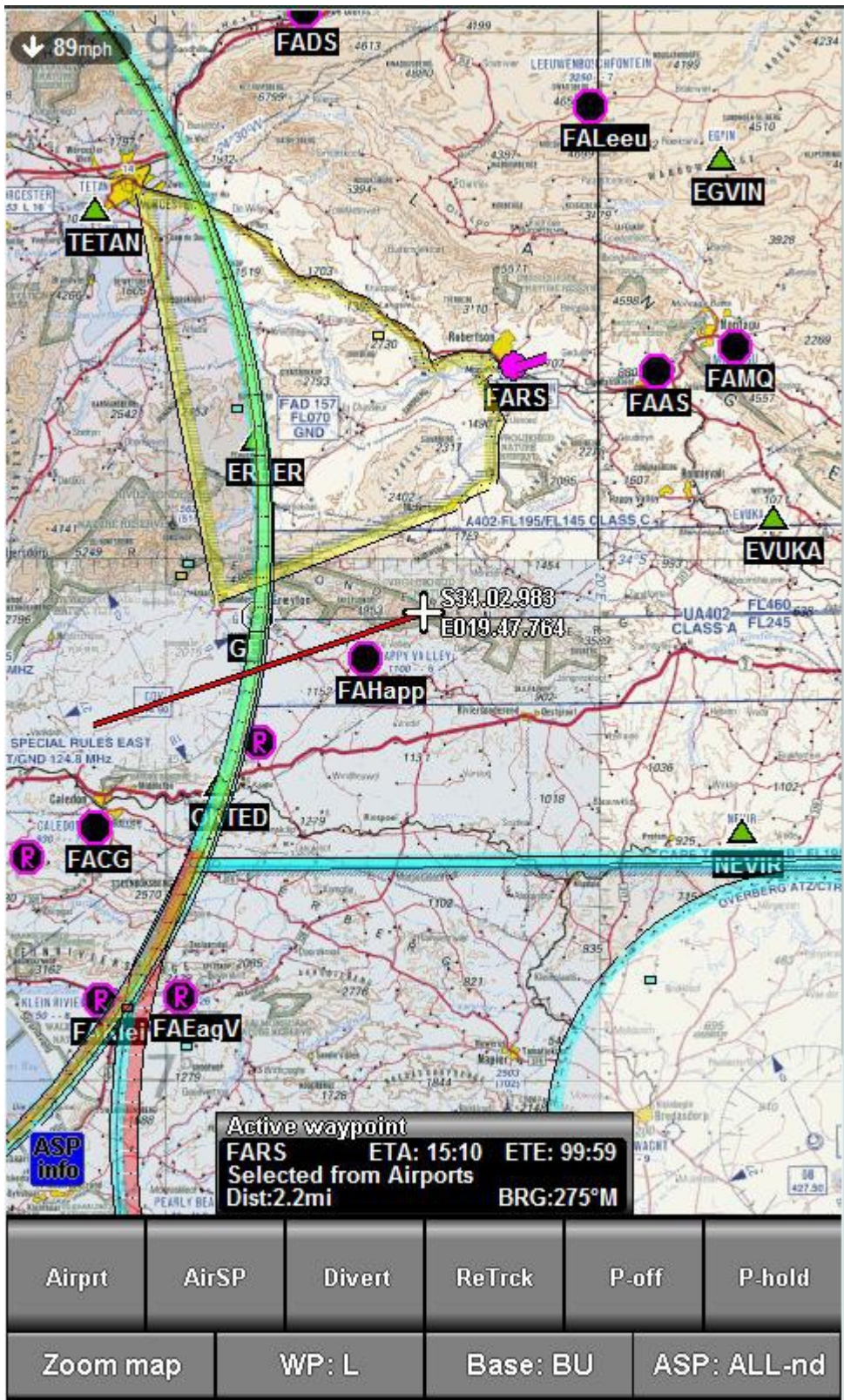

## The rotary controls

Rotary controls can take on various functions depending on current context:

### Normal page mode

Page 1	Baro: 1013	ALT: 2800ft	Head: 340
Page 1	GPS OBS: 251	OBS: 040	Head: 340

In normal page mode you have two options for rotary control functions. To flip between the two options press the page rotary control.

### Map mode

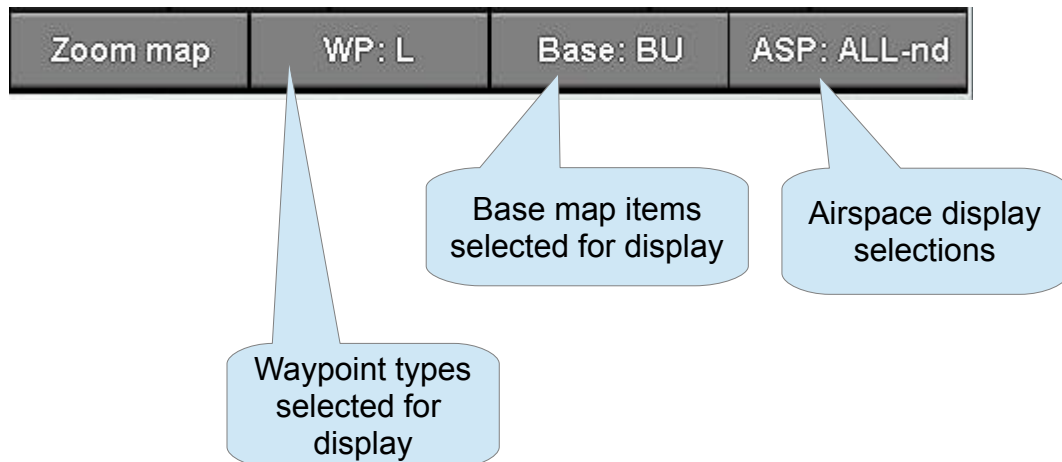

### Menu mode

	Select	Line Up/Down	Page Up/Down
--	--------	--------------	--------------

In Menu mode you can navigate the menus using the touch screen or you can use the rotary controls.

### Other modes

Several functions such as the flight planning tool and flight plan live display will use the rotary controls for their own functions.

## Waypoint selection system

The EFIS contains a common structure to view or select waypoints. Depending on the context, the function operates in slightly differing ways.

Here we start with the most common – using the “Direct goto” function to select a waypoint.

Touch the NAV soft key button



Then select:

→ **GPS: Goto waypoint and set NAV**

This shows you a display like:

All waypoints - SELECT mode		
N FARS,	Robertson	2.2mi ←
N FAAS,	Ashton Airport, SOUTH AFRICA	7.4mi →
N FAMQ,	Montagu	12.6mi →
N FALeeu,	Leeuwenboschfontein	16.7mi ↑
N FANadi,	Nadini	24.0mi ↑
N FAHapp,	Happy Valley	23.7mi ↓
N FADoor,	De Doorns	27.9mi ↖
N FADS,	De Doorns Airport, SOUTH AFR	28.0mi ↖
N FAWC,	Worcester	31.4mi ←
N FAGI,	Grootvlei (Cape)	32.2mi ↓

↑	Pick from flightplan		
↓	Filter Types	Search	✕
	Select	Line Up/Down	Page Up/Down

Waypoints appear in order of distance from your current location.

The system maintains the nearest 20,000 waypoints from your database in memory and this is periodically refreshed as you change position. Waypoints that are very far away are not considered. Regardless if the memory list includes a waypoint or not, if it is contained in the database you can search for this.

Note the  button.

Tap this to bring up a popup where you can select which types of waypoints to include in the list. Waypoint types are “Airports”, “Nav aids”, “intersections”, etc.



You may select a waypoint that is included on any flight plans you have stored on your system. You will select the flight plan file name and then can pick the desired waypoint from that flight plan.



Tap the “Search” icon to activate the search function.

You can search short or long waypoint names. You can also select the search method. Either the waypoint name must start with the letters given in your search or you may choose “Contains”. In this case the name will match if any part of it contains your search criteria.

When you have finished your search you can tap the enter key on the keyboard. The search criteria will remain active until you either select a waypoint or tap the Search icon again which is now labeled “LEAVE” to resume normal mode where waypoints are sorted by distance from your current location.

Note: As you enter letters for your search criteria the system scans the database for matches and lists these in order of occurrence. In most cases you only need to enter a few characters to arrive at your desired waypoint.

The display shows you the top two occurrences – more will be hidden behind the entry dialog. Once you are confident that your desired waypoint is visible in the list, tap the ENTER button to close the dialog. The list will remain in search mode until you end it or select a waypoint.



## Waypoint search

All waypoints - SELECT mode

N FACont,	Contermanskloof	78.0mi ←
N FACT,	Cape Town Intl.	77.4mi ←

Search short names  Short  Long  Starts with

FAC\_\_

1	2	3	4	5	6	7	8
9	-	=	[	]	,	.	/
;	'						
A	B	C	D	E	F	G	H
I	J	K	L	M	N	O	P
Q	R	S	T	U	V	W	X
Y	Z		Space				
Shift		Del				Enter	



## The installation tasks menu

This is a menu that you will use fairly often – mostly to install updated databases.

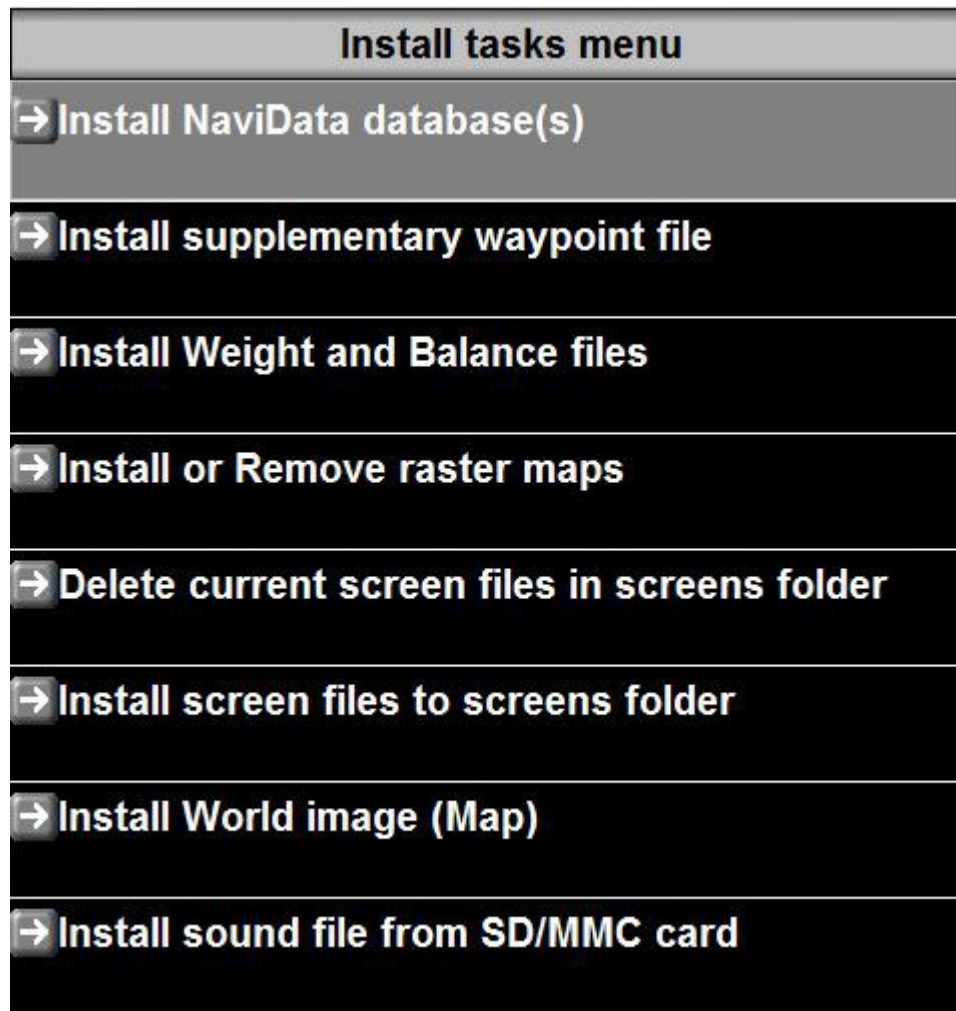

### ***Install NaviData database(s)***

Navigation databases for your EFIS are available from various sources. You can use subscription based products from Jeppesen, PocketFMS and Easyplan.

There are also free databases available, for example the data used for North America is supplied by the MGL Avionics user forum based on the regular FAA data release.

You can also create your own data using the MGL Central application.

You can install up to 26 Databases and 26 secondary databases. In most cases however you will only install a single database.

The primary database file name is NavidatA.ewd. Further primary files are NavidatB.ewd, NavidatC.ewd.... up to NavidatZ.ewd.

Similar to this the secondary databases are named Snavi.ewd or SnaviA.ewd to SnaviZ,ewd

Note: At any one time ONE primary and ONE secondary navigation database can be active. You select which one in the NAV menu. Using this scheme you can create different navigation

databases for different regions or use different databases for the same region.

Often you might want to use a subscription product as primary database and create your own database using the MGL Central application for your own airfields or waypoints as secondary database.

You can rename the filenames for your databases as you like to assign them to regions A to Z. However subscription products must remain primary databases.

### ***Install supplementary waypoint file***

This file refers to the file “Waypoint.ewd” in your internal disks navdata folder. This file is always there. If you delete it it will be recreated (as empty file).

You can add and edit this database in your MX1 (under the menu function “Supplementary Waypoint editor”). You can also create such a file using the MGL Central application.

Installing this file overwrites the internal file and also tells you MX1 to add the waypoints in the file to its currently active list. You can also just copy the file using the file manager but in that case the MX1 will only look at the file some other time based on circumstance).

### ***Install weight and balance files***

This installs the files WB.MIF and WB.DAT. The WB.MIF file is an image file created by the MGL BMP to MIF converter (available for download from the MGL Avionics website). The WB.DAT file defines your weight and balance stations and related information. This file is created in your MX1 Screen designer and simulator application.

Also see the separate chapter on weight and balance in this manual.

### ***Install or remove raster maps***

Raster maps are map images such as sectionals. They are converted and geo-referenced using the MGL Avionics MAPMAKER-2 application you can download from the MGL Avionics website.

Map files contain the position of the top left corner of the map as reference and use the file extension “.MAP”. However, you can rename these files and give them extensions such as:

.VFR .TAC .HIG .LOW .IFR .WAC

This allows you to install several sets of maps. You can then select the desired map type from the map “Mode” soft key button.

Note: You can also use the file manager to copy map files directly if you like. Copy them to or from the “Maps” folder of your internal disk.

### ***Delete current screen files in screens folder***

This can be used to remove all custom screens that are currently in the “Screens” folder of your internal disk.

### ***Install screen files to screen folder***

Use this function to install custom screen designs into your “Screens” folder.

The function will copy all screen files located on your external SD card and overwrite any that exist with the same name.

Screen files have names such as Flight1.sdf, Engine1.sdf, etc

The number in the name tells the MX1 which page to use these files on. You can edit the filenames to move the screen content to a new page.

Note: There is no file renaming function on the EFIS – use a laptop or PC with an SD card reader to rename the files.

Note: The dfile.bin screen file system is a virtual file system contained in a single file. This can be created by the MX1 screen designer and replaces the built in screens. This file is NOT copied by this function. Please use the file manager to copy the dfile.bin to the Screens folder.

### ***Install World image (Map)***

This is a large image file in standard Windows BMP format. It is used as a map for large area zoom levels (continent wide). The image contains all of the Worlds land and sea mass.

The image size is 7200x3600 pixels wide and must have 32bit color depth.

The image is installed in the “Terrain” folder.

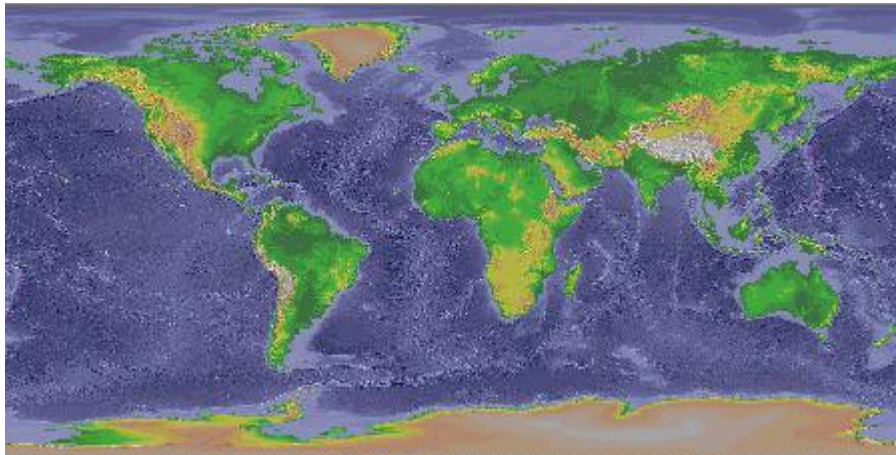

Should you wish to replace the image supplied by MGL Avionics (shown here), please ensure that you use the same map projection.

### ***Install sound file from SD/MMC card***

The sound file is named SOUNDS.ESD and is created by the Enigma Voice application available for download on the MGL Avionics website. It converts standard 8-bit, 8Khz sample rate, monaural sounds in WAV format. MGL Avionics offers two of these files for download on their website: A male and a female voice version.

The sound file is used for the various voice annunciations and also contains some other sounds such as market beacon sounds.

This file is installed on the root folder of the internal disk and loaded by the MX1 for use at system startup.

## Common tasks menu

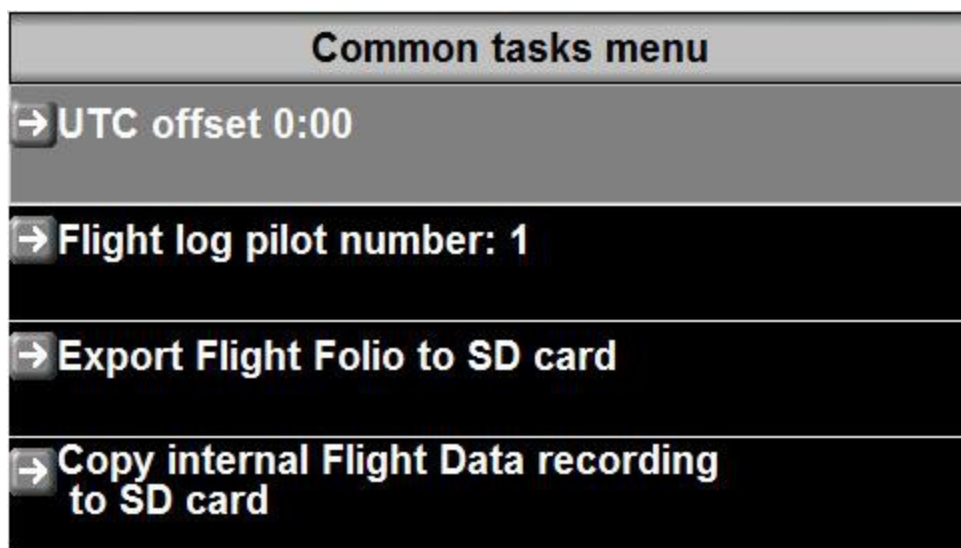

### ***UTC offset***

Enter the offset in steps of 15 minutes from UTC to your local time. This value will be used to calculate UTC from your local time or your local time from UTC GPS time if you are using the option to set your internal real time clock from the GPS (See MX1 installation manual).

### ***Flight log pilot number***

You can assign a number that will be included in any future recordings of the flight log. The flight log is a flight folio style log that is created based on your flight detection settings in the Operations setup menu. The flight folio contains information such as date and time of take-off, flight duration, speeds and altitude reached and some engine data such as hobbs.

### ***Export Flight Folio to SD card***

This function copies the internal flight log to a human readable text file onto your external SD card.

### ***Copy internal Flight Data recording to SD card***

The MX1 records all known data about your flight (primary flight, engine data, attitudes, navigation, etc) once per second to an internal non-volatile memory. It records the last hour of data even if multiple flights.

This function allows you to extract this data onto an external SD card. It can be viewed in the IEFIS flight data recording viewer. This application is a free download from the MGL Avionics

website.

### 3D View setup

This menu contains items that affect your horizon display.



## ***Attitude graticule display***

This allows you to switch the pitch and roll displays on or off.

## ***View uses pressure altitude***

Here you can select if your forward view should use pressure altitude (with local barometric correction) or altitude from your GPS.

The recommendation is to use pressure altitude unless you are flying in an area that has wide area GPS augmentation coverage that can significantly reduce vertical errors of the GPS position.

## ***Show...***

Here you can select from a variety of on-screen heading displays in true or magnetic heading. These displays are effectively all tapes. Choose which one suits you best.

## ***Flight path display***

You can select to compute an attitude estimate (pitch and bank) using your built in GPS. This is called “Flight path display”. It estimates your attitude based on how you move in three dimensional space. It has a slight lag but has the advantage that unlike a gyro based system it never drifts. It has several disadvantages as well. It cannot tell if you are upside down and it will show a nose down attitude if you are stalling (as your flight path is going down).

Nevertheless it can be very useful. The recommendation is to use this as additional reference if you have a multipanel system.

## ***Flight director***

The flight director is a set of purple triangles nesting over the center yellow triangles of your horizon display. If you follow these triangles as they move away from the yellow triangles you will be flying according to your turnrate, ascent and decent settings in your autopilot setup menu (even if you are not using an actual autopilot). If you engage the autopilot, the autopilot follows the flight director – the flight director in this case uses white triangles so this is a nice way of confirming that your autopilot is engaged and is following the flight director.



## ***Allow helicopter pads***

Select if you would like the horizon display to indicate nearby helicopter pads. Generally you



would not select this if you are flying a three axis aircraft.

### **Show 3D highway in the sky**

Select if you would like to make use of the 3D highway in the sky. This shows you green boxes you “fly” through to stay on track and on altitude.

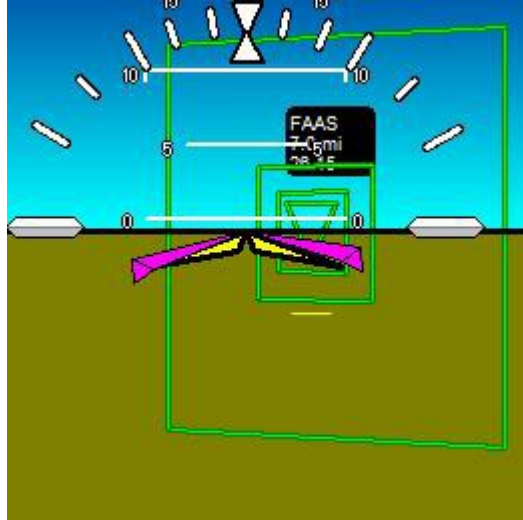

Here you see a highway in the sky and we are getting close to the waypoint. The waypoint “paddle” is shown with a black background indicating that it is the active waypoint.

The last highway box is a triangle with the bottom apex over the waypoint location.

If you are flying a flight plan and you are getting close to a waypoint that is not the last in your flight plan you will see a second set of highway in the sky boxes starting at the next waypoint and possibly heading in a new direction.

### **HITS follows altitude bug**

Select if you would like the highway in the sky (HITS) to follow your current altitude or should it stay at the altitude you select using the altitude bug rotary control.

### **Velocity...**

You can switch the velocity vector display on or off. The display looks like VV.

This vector shows you where you are going both vertical as well as horizontal. You can also select if you would like to use the GPS ground track or the magnetic heading source (compensated for local variation) as reference.

If you select the GPS the VV vector can only move up or down.

Note: If using magnetic heading a source you must ensure that your source is very accurate in order to obtain a meaningful vector.

## ***Pitch ladder banks***

Select if you would like your pitch ladder to bank or to remain vertical regardless of roll attitude.

## ***Enable 2D traffic on SV***

This function, if enabled will show you nearby traffic as symbols centered around the center of your horizon display. Traffic in front of you is shown above the center, behind is below and left and right as is.

A line is drawn to the closest traffic object from your horizon center.

If a traffic object is closer than the limits you have specified in your traffic monitoring setup (under your system setup menu) then the line will flash to highlight the danger.

Each traffic symbol is shown with a positive or negative number showing the relative altitude in steps of 100 ft to your altitude. Positive means the traffic is above you, negative means the traffic is below you. The line is also marked with the distance to the closest traffic object.

The same symbols are also used on maps to show traffic.

