

RV-2

Universal Turbine RPM / RPM factor display

Operating Manual – English 1.01



Introduction

The RV-2 is a 2 1/4" instrument providing a universal turbine RPM display that can be adapted to a variety of roles. Typical uses are turbine RPM displays for N1 or N2. The RV-2 can use standard tach genies but can also be used with almost any electrical signal related to turbine RPM.

The RV-2 displays RPM in a digital readout as well as in a scalable analog bar graph display. In addition the RV-2 provides a 24 entry automatic flight log that stores the duration of each of the last 24 flights. It also has a Hobbs meter (can be set to the current turbine time) which is password protected, a turbine running timer/flight timer and a programmable maintenance timer to schedule routine engine maintenance. The RV-2 also features a programmable RPM high alarm as well as it records the maximum RPM reached in permanent memory.

1 Features

- Measures RPM from 0 to 99999 RPM or a factor in percent relative to a value that can be entered into the unit. For example 50000 RPM = 100%
- Includes a 24 entry automatic flight log
- Includes a settable Hobbs meter (password protected) and a turbine running timer/flight timer
- Contains a programmable high RPM alarm
- Contains a programmable maintenance timer for scheduled routine engine maintenance
- Records maximum RPM reached in permanent memory
- Scalable analog bar graph indicating RPM
- Standard 2 1/4" aircraft enclosure (can be front or rear mounted)
- Rotary control plus 2 independent buttons for easy menu navigation and user input
- External alarm output as well as a red LED illuminates when the alarm has been activated
- Large backlit graphic LCD with adjustable contrast
- Wide input supply voltage range of 8 to 30V DC with built in voltage reversal and over voltage protection for harsh electrical environments
- Light weight design
- 1 year limited warranty

2 RV-2 Layout

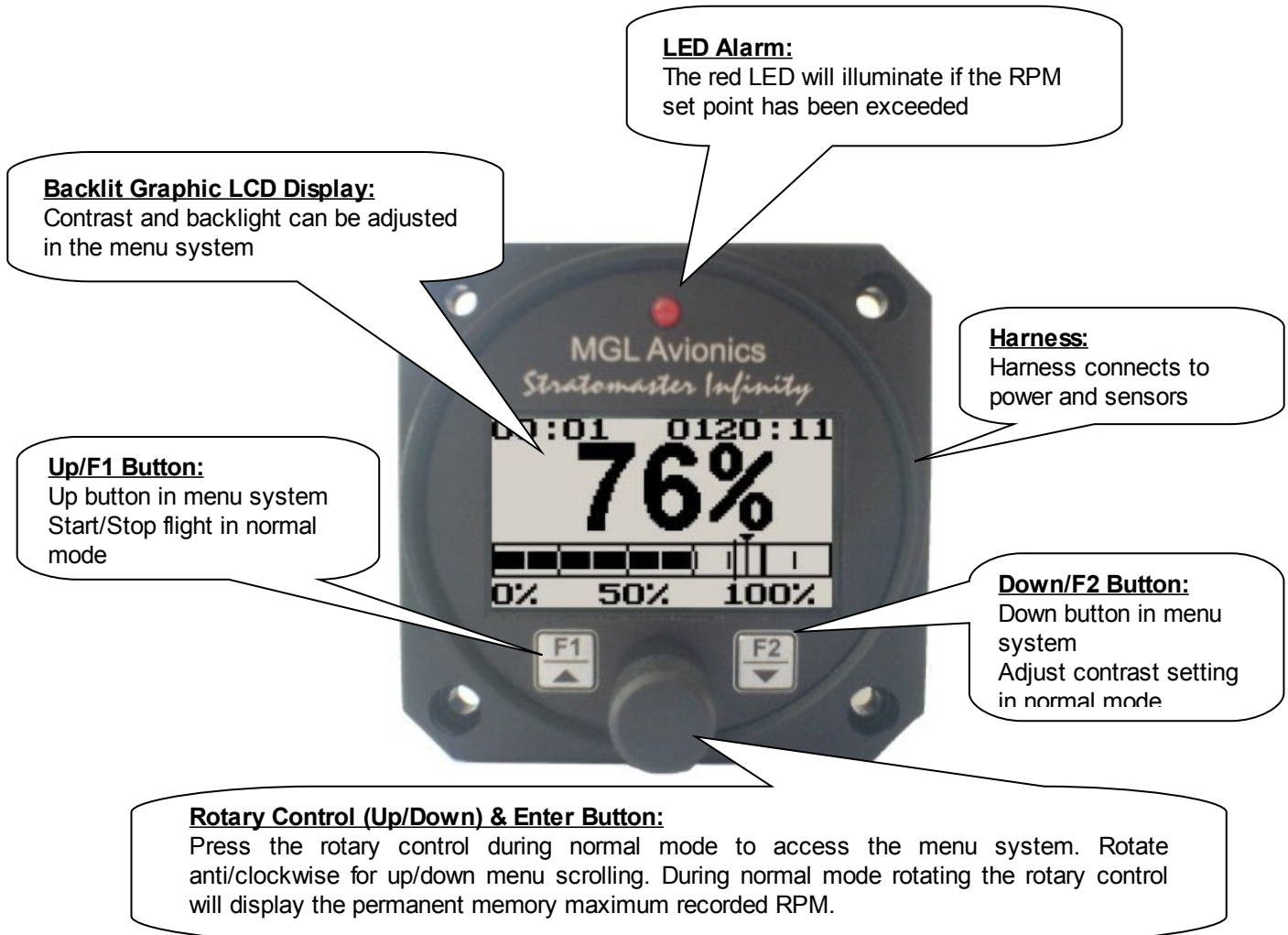

3 About RPM Measurements

Generally, there are two different methods of measuring RPM. The RV-2 unit can be setup to perform either method. The first method involves counting pulses generated by some device in the turbine. Pulses are counted over a period of time and the result is then used to calculate RPM. This method requires a high number of pulses due to the short measurement interval of $\frac{1}{2}$ second. This method is suitable for many smaller turbines that do not provide a standard tach generator output but have other types of pickup senders such as gear tooth senders.

Engines producing few pulses require a different method. Here the RV-2 can use the time it takes to generate only two pulses as bases for the RPM calculation. This is the method usually used for standard 70 Hz tach generators. The particular method to be used and the number of pulses per revolution are entered as part of the RV-2 setup as given below.

4 Main Display

The RV-2 can be configured to display RPM or as a factor in percent relative to a value that can be entered into the unit.

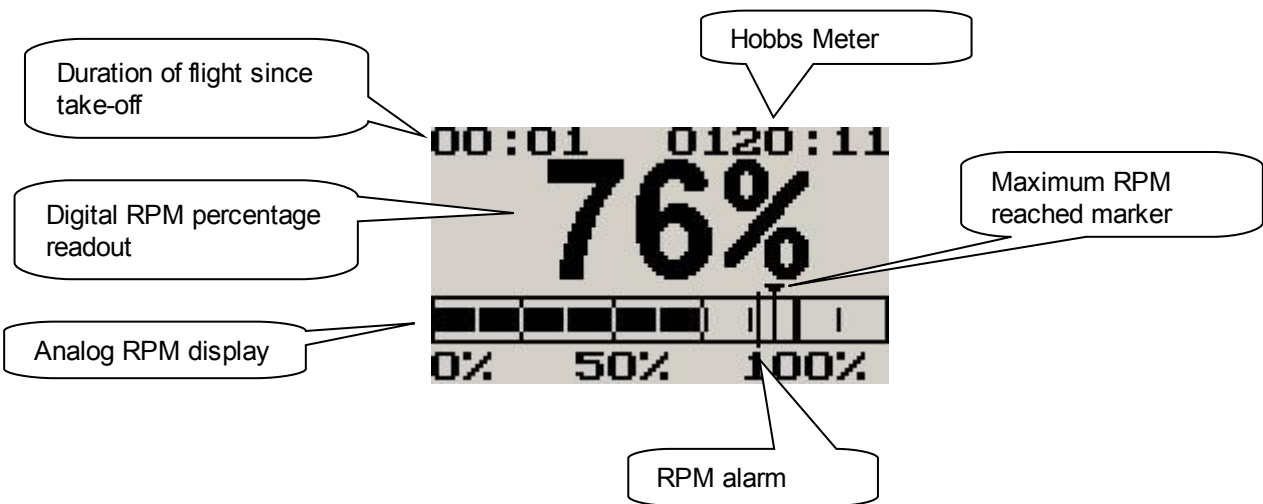
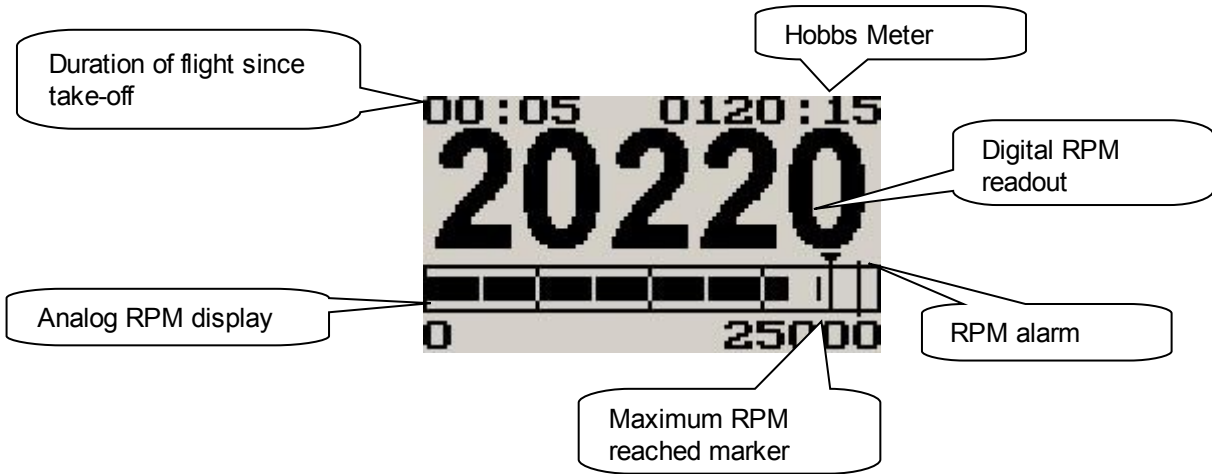

4.1 Start / Stop Flight Display



Press the F1 key during the normal display mode to manually start/stop a flight. This key is only active if the RV-2 is setup to select the manual flight option under the "FLIGHT LOG" setup menu.

4.2 Contrast Display

This display can be accessed by pressing the F2 key during the normal display mode. This is a quick access key to the same contrast menu as in the menu system.

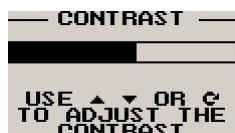

Select this menu option to adjust the display contrast.

4.3 Maximum RPM Display

This display can be accessed by rotating the rotary control either clockwise or anticlockwise during the normal display mode. Pressing the F1 key again will reset the maximum RPM to the current RPM. Pressing any other key will cause the RV-2 to resume to the normal display mode. To avoid false recordings, the maximum RPM function is only activated 10 seconds after the instrument has powered up.



Note: The permanent maximum values are stored in non-volatile memory and are recalled on power-up.

5 Maintenance Timer

The purpose of this function is to assist you in determining remaining hours until maintenance will be required. It is not intended as a replacement for the aircraft's maintenance log. It is therefore important that the aircraft's maintenance log be maintained in the normal manner. You should further use your own discretion in performing maintenance earlier than indicated should any aircraft performance problems arise.

A maximum of 999 hours can be entered as a maintenance interval. The RV-2 will deduct actual engine running time from the maintenance interval hours as set and will display the reminder message on startup when zero hours are remaining. The reminder message will automatically disappear after 5 seconds or if the pilot presses any key. Engine running time for the purpose of the maintenance timer is defined as the run time where the engine RPM is greater than the preset RPM for the Hobbs meter.

**MAINTENANCE
TIMER HAS
EXPIRED**

6 Menu System

Pressing the rotary control button during the normal display mode will cause the RV-2 to enter the menu system. Use the up/down keys or the rotary control to navigate through the menu system.

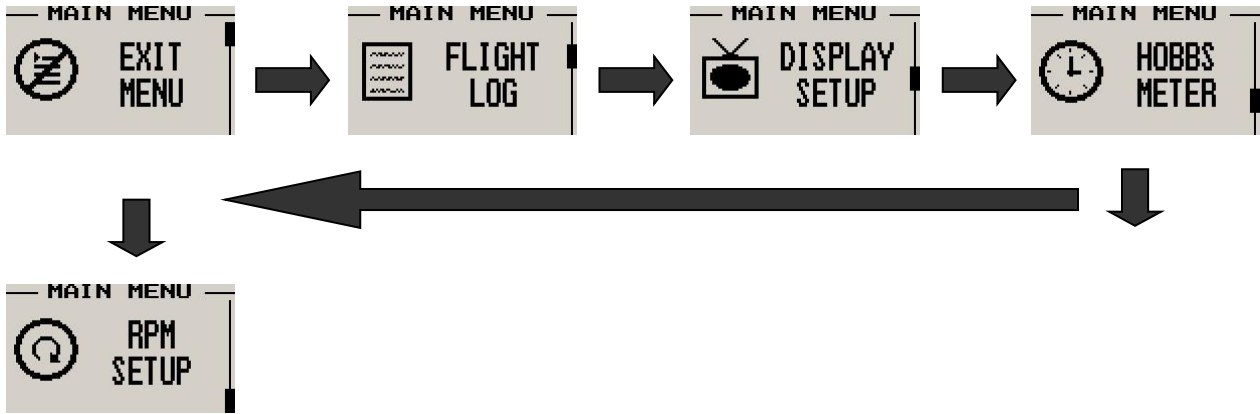

6.1 Exit Menu



Pressing the rotary control on this menu item will cause the RV-2 to exit the menu system. All changes made during navigation of the menu system will be saved in non-volatile memory on exiting the menu system. If you remove power before exiting the menu the instrument will not save any changes.

6.2 Flight Log



Select whether the instrument should detect the start and end of flights automatically or if you would like to do this manually. We recommend you select automatic flight detect. With automatic flight detection, flights will start logging when the engine RPM is above the take-off limit. A flight is considered ended when the engine RPM is less the RPM take-off limit for more then 30 seconds.



Move the highlight over the “DONE” option and press the rotary button to return to the main menu.

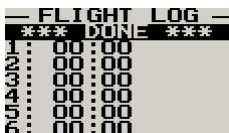

Select this function to view the flight log. The flight log contains the duration of each of the last 24 logged flights. Duration is displayed in hours and minutes. Use the up/down or the rotary control to navigate through the log. Empty log entries are shown as “-----”.

Note: You cannot select this function while a flight is in progress.



Pressing the F1 key will erase all the flight log entries.



Select whether you want the RV-2 to automatically detect a flight or whether the pilot must press the F1 key to start/stop a flight. We recommend you select automatic flight detection.



This menu option is only shown if the “detect” flight mode is selected. Enter the engine RPM take-off threshold that you want a flight log entry to start.

6.3 Display Setup



Move the highlight over the “DONE” menu option and press the rotary button to return to the main menu.

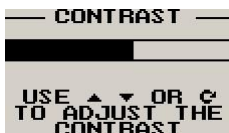

Select this menu option to adjust the display contrast.



Select this menu option to turn the backlight on or off.

6.4 Hobbs Meter

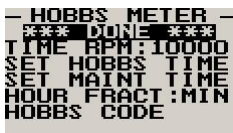

Move the highlight over the “DONE” menu option and press the rotary button to return to the main menu.

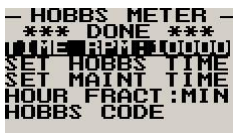

Enter the RPM limit in which the Hobbs meter/Maintenance timer must start counting.

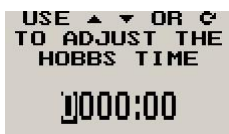
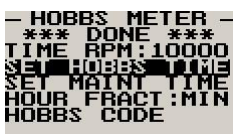

This function allows you to set the engine Hobbs meter to any value. Typically, you would use this function to set the Hobbs meter to the current known engine time. Use the up/down or the rotary control to change the value. Press the rotary control to accept and exit the menu option. If the Hobbs code is set to another value beside zero, then the pilot will be prompted to enter the Hobbs access code before allowing him to change the Hobbs time. This feature is useful for charted and flying school planes.

```

- HOBBS METER -
*** DONE ***
HOBBS RPM:1000
SET HOBBS TIME
SET MAINT TIME
HOUR FRACT:MIN
HOBBS CODE
    
```

```

USE ▲ ▼ OR ⌚
TO ADJUST THE
MAINTENANCE
TIME
000 Hours
    
```

This function allows you to set an engine maintenance timer. This timer is set in engine hours and it will count down to zero when the engine RPM is greater than the Hobbs RPM limit. A good use for this function is to set the hours until your next spark plug change or engine inspection. Use the up/down or the rotary control to change the value. Press the rotary control to accept and exit the menu option.

```

- HOBBS METER -
*** DONE ***
TIME RPM:10000
SET HOBBS TIME
SET MAINT TIME
HOUR FRACT:MIN
HOBBS CODE
    
```

Select if you would like the hour to be displayed in decimal fractions (0-99) or minutes (0-59). This setting influences the current flight time display and the flight log.

```

- HOBBS METER -
*** DONE ***
TIME RPM:10000
SET HOBBS TIME
SET MAINT TIME
HOUR FRACT:MIN
HOBBS CODE
    
```

This menu option allows you to change the Hobbs access code. You will first be prompted to enter the current code followed by entering in a new code followed by re-entering the new code. If the new code and the re-entered code is the same, then the Hobbs access code will be changed. **Default code is 0000.**

```

ENTER CURRENT
CODE
0000
    
```



```

ENTER NEW
CODE
0000
    
```



```

CONFIRM NEW
CODE
0000
    
```



```

MESSAGE
! CODE
CHANGED
    
```

6.5 RPM Setup

```

- MAIN MENU -
RPM
SETUP
    
```

All the RPM related settings can be setup here.

```

- RPM SETUP -
*** DONE ***
DISP: PERCENT
100/RPM: 50000
ALM ON/OFF: ON
ALARM: 45000
PUL/REV: 6.00
PULSE: PUL$E
    
```

Move the highlight over the "DONE" menu option and press the rotary button to return to the main menu.

```

- RPM SETUP -
*** DONE ***
DISP: PERCENT
100/RPM: 50000
ALM ON/OFF: ON
ALARM: 45000
PUL/REV: 6.00
PULSE: PUL$E
    
```

```

- RPM SETUP -
*** DONE ***
DISP: RPM
SCALE: 25000
ALM ON/OFF: ON
ALARM: 45000
PUL/REV: 6.00
PULSE: PUL$E
    
```

Select whether you want the RV-2 to display the actual RPM or to display RPM as a percentage of the 100% RPM value. Use the actual RPM display to initially setup the RV-2, once you are satisfied that your calibration is correct, then swap over to the factor display.

Display in Percentage mode

```

- RPM SETUP -
*** DONE ***
DISP: PERCENT
100/RPM: 50000
ALM ON/OFF: ON
ALARM: 45000
PUL/REV: 6.00
PULSE: PUL$E
    
```

Select the RPM that corresponds to a 100% power setting on your turbine. Note: you can adjust this value slightly if you are running out of calibration resolution for the "PUL/REV" setting and still need to coincide with the 100 percent setting.

Display in RPM mode

```

- RPM SETUP -
*** DONE ***
DISP: RPM
SCALE: 25000
ALM ON/OFF: ON
ALARM: 45000
PUL/REV: 6.00
PULSE: PUL$E
    
```

Select the maximum value that you want the RPM analog bar graph display to show. This can give you increased display resolution.

Setups for both modes

```

RPM SETUP
*** DONE ***
DISP: PERCENT
100/RPM: 50000
ALM ON/OFF: ON
ALARM: 45000
PUL/REV: 6.00
PULSE: PULSE
    
```

Select whether you want the RPM alarm to be turned on or off.

```

RPM SETUP
*** DONE ***
DISP: PERCENT
100/RPM: 50000
ALM ON/OFF: ON
ALARM: 45000
PUL/REV: 6.00
PULSE: PULSE
    
```

Enter the RPM alarm activation threshold. Any RPM value above this value will activate the alarm.

```

RPM SETUP
*** DONE ***
DISP: PERCENT
100/RPM: 50000
ALM ON/OFF: ON
ALARM: 45000
PUL/REV: 6.00
PULSE: PULSE
    
```

Enter the number of pulses per revolution. You can enter fractional values as well.
 Example: You have a turbine that produces 8 pulses per revolution – set to 8.00
 Example: You have a turbine that produces 1 pulse every 10 revolutions – set to 0.10

```

RPM SETUP
*** DONE ***
DISP: PERCENT
100/RPM: 50000
ALM ON/OFF: ON
ALARM: 45000
PUL/REV: 6.00
PULSE: PULSE
    
```

Select if you want the RV-2 to count pulses from the engine for 1/2 second period (fast) or if you want the RV-2 to use the time between pulses to calculate revs (slow).

As a general rule, for maximum display resolution, choose as follows:
 Signal with many pulses per 1/2 second – choose “PULSE”.
 Signal with few pulses – choose “TIME”.

7 Loading factory default settings

Pressing and holding the F1 and F2 simultaneously on power up will cause the RV-2 to load preprogrammed factory default settings. The following screen will be displayed:

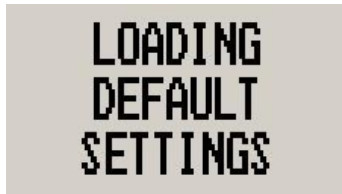

8 Operating the alarms

If the alarm is activated, the corresponding item on the display will flash. At the same time the externally available alarm switch will close. The switch will remain closed until any button is pressed to acknowledge the alarm or until the condition(s) that activated the alarm no longer exist. The alarm output can be used to switch an external alarm indicator. The external alarm switch is an open collector transistor switch to ground with a maximum rating of 0.5A DC. It is possible to wire the alarm contacts of several Stratomaster instruments in parallel should this be desired. To avoid false activation of the alarms, the alarm function is only active 10 seconds after the instrument has powered up.

9 Cleaning

The unit should not be cleaned with any abrasive substances. The screen is very sensitive to certain cleaning materials and should only be cleaned using a clean, damp cloth.

Warning: The RV-2 is not waterproof. Serious damage could occur if the unit is exposed to water and/or spray jets.

10 RV-2 Specifications

Operating Temperature Range	-10°C to 50°C (14°F to 122°F)
Storage Temperature Range	-20°C to 80°C (-4°F to 176°F)
Humidity	<85% non-condensing
Power Supply	8 to 30Vdc SMPS (switch mode power supply) with built in 33V over voltage and reverse voltage protection
Current Consumption	Approx. 38mA @ 13.8V (backlight on) 10mA @13.8V (backlight off)
Display	114x64 graphic LCD display. Contrast and backlight is user configurable, green/yellow backlight
Dimensions	see Infinity series dimensional drawing
Enclosure	2 1/4" ABS, black in color, front or rear mounting
Weight	Approx. 112 grams
Alarm contact current rating	Open collector transistor switch to ground. Maximum rating 0.5A DC
Non-volatile memory storage	100000 write cycles
Rev counter input	Range: 0-99999 RPM. Minimum signal for stable display: 5Vpp. Fully A/C coupled, maximum voltage +/- 40V. RF noise filter plus Schmitt-trigger based input

11 Installation

After you have connected the rev counter terminal to the signal source you need to set the number of pulses per revolution under the "RPM SETUP" menu. The calibration itself depends on your engine type and what kind of signal you are using.

Installation of the RV-2 is quite straight forward in most cases. The drawing in section 11.2 shows a typical connection for a standard 3 phase tach generator. Note that only a single phase needs to be used. The RV-2 input is quite universally usable. The rev counter input on the RV-2 is AC coupled and can be used with signals from about 5Vpp to as much as 100Vpp. This means that the voltage signal may have a DC voltage superimposed without affecting the instrument. For example, if you have a signal that varies in voltage from 5V to 8V with every pulse, it can be used with the RV-2. Should your source generate a signal voltage below the minimum required, you will need to install a suitable amplifier or replace the pickup sensor with a type that has a larger output voltage.

A noise filter is included that results in the input ignoring any noise signals as long as this is below the detection threshold of about 2.5Vpp. The input impedance of the rev counter input is approximately 10Kohm. You can use series resistors as well as load resistors for applications that have unusual signals.

Please note: The +5V supply line is unprotected and intended only for the supply of a hall-effect , optical or gear tooth sensors. Connecting any voltages (such as the 12V supply) to this line could destroy the instrument. The +5V line may supply currents of up to 30mA. Should your sensor require greater currents you must supply it from another source.

Please note: It is essential that a single wire be connected from the minus terminal of the instrument to the engine block. This wire must not be used to share currents with other electrical users as this can affect accuracy of readings.

11.1 Adjusting RPM sensitivity

The RV-2 has a sensitivity adjustment trimmer as shown in the picture below. Adjust this trimmer using a small screwdriver such that you get stable RPM readings over the entire rev band of your engine. If your sensitivity is too high, you may get unstable RPM readings (usually at higher RPM as electrical noise in the ignition system increases). If the sensitivity is too low the RPM reading may remain at zero. Fully clockwise = maximum sensitivity.

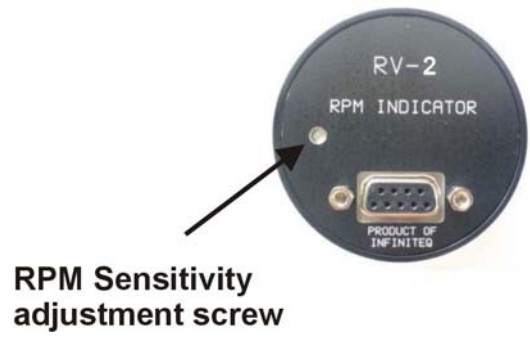

11.2 RV-2 DB9 Cable connections

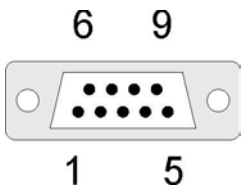

DB 9 Pin	Color	Function
1	Black	Ground
4	NC	Airtalk communication (Not connected) Used for firmware upgrading
5	Blue	RPM input
6	Red	8-30Vdc power
7	Brown	+5VDC Power Out
9	White	Alarm Output

11.3 RV-2 Connection Diagram

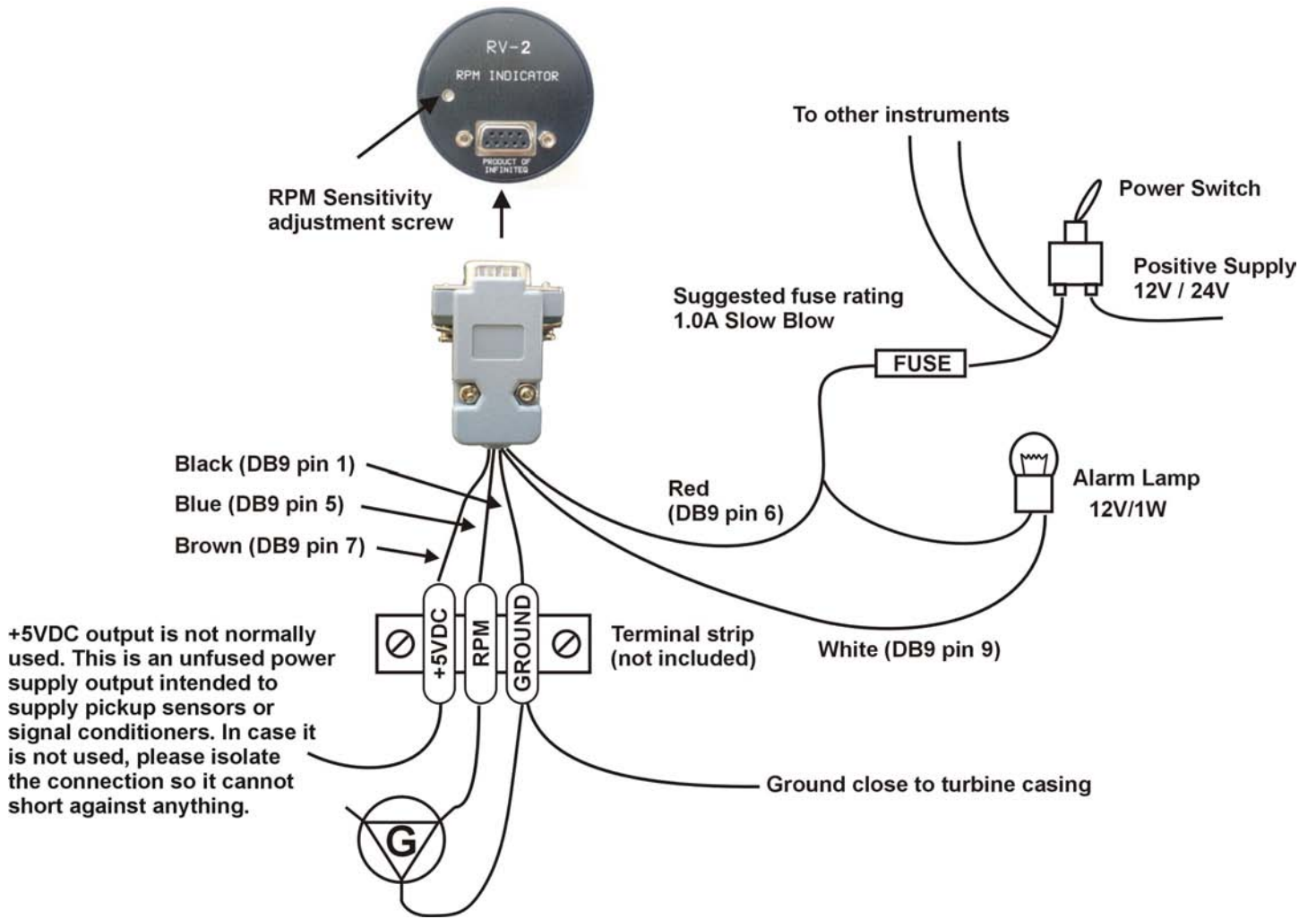

The use of an external 1A fuse is recommended. Connect the supply terminals to your aircraft's power supply. The RV-2 can be used on both 12V and 24V without the use of any pre-regulators. Ensure that the supply voltage will not drop below 8V during operation as this may result in incorrect readings.

11.4 Various other pickup/sensor installation possibilities

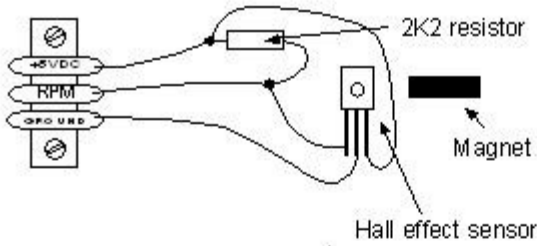

Typical hall effect sensor installation detects the passing of a magnet suitably fixed to prop flanges or shafts.

Magnetic pickup with Hall effect sensor

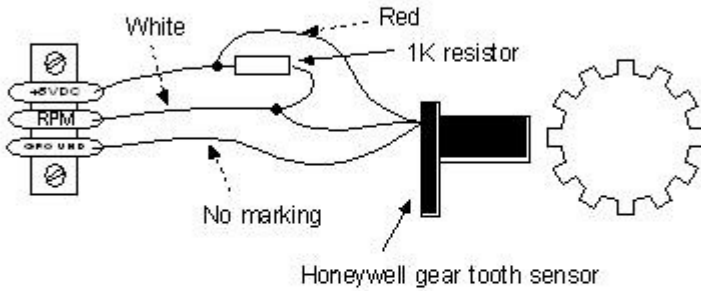

The gear tooth sensor is a popular pickup used on the pre-rotation gear of a gyro plane (rotor speed indication).

Magnetic pickup with active gear tooth sensor

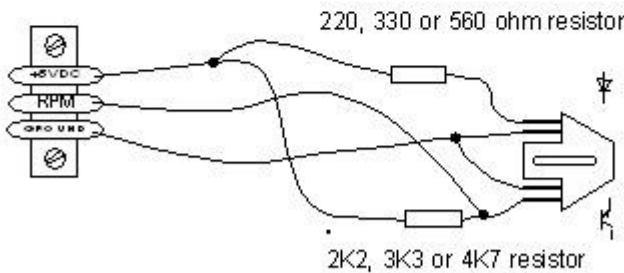

The optical reflective pickup can provide a simple means of contactless RPM sensing in difficult installations.

Optical, reflective sensor

12 Warranty

This product carries a warranty for a period of one year from date of purchase against faulty workmanship or defective materials, provided there is no evidence that the unit has been mishandled or misused. Warranty is limited to the replacement of faulty components and includes the cost of labour. Shipping costs are for the account of the purchaser.

Note: Product warranty excludes damages caused by unprotected, unsuitable or incorrectly wired electrical supplies and or sensors, and damage caused by inductive loads.

13 Disclaimer

Operation of this instrument is the sole responsibility of the purchaser of the unit. The user must make themselves familiar with the operation of this instrument and the effect of any possible failure or malfunction.

This instrument is not certified by the FAA. Fitting of this instrument to certified aircraft is subject to the rules and conditions pertaining to such in your country. Please check with your local aviation authorities if in doubt. This instrument is intended for ultralight, microlight, homebuilt and experimental aircraft. Operation of this instrument is the sole responsibility of the pilot in command (PIC) of the aircraft. This person must be proficient and carry a valid and relevant pilot's license. This person has to make themselves familiar with the operation of this instrument and the effect of any possible failure or malfunction. Under no circumstances does the manufacturer condone usage of this instrument for IFR flights.

The manufacturer reserves the right to alter any specification without notice.

Other instruments in the *Stratomaster Infinity* series

ALT-1	Precision encoding altimeter and vertical speed indicator
ALT-2	Precision encoding altimeter and vertical speed indicator with a serial RS232 transponder output
ASI-1	Airspeed indicator (ASI) with automatic flight log
ASX-1	Encoding aviation altimeter with serial output and airspeed indicator (ASI)
AV-1	Artificial horizon and magnetic compass indicator
BAT-1	Battery voltage and current monitor
E-3	Universal engine monitor
FF-1	Fuel Computer (single or dual fuel tanks)
GF-1	+/-10G tilt compensated dual range G-force meter
MAP-1	Manifold pressure and RPM Indicator
RV-1	Universal engine RPM and rotor RPM Indicator
RV-2	Universal turbine RPM / RPM factor display
RTC-2	Aviation real time clock (RTC) and outside air temperature (OAT) display
TC-1	4-Channel thermocouple indicator
TP-1	Universal temperature and pressure gauge