

# RV-3

## Universal engine RPM and rotor RPM indicator

Operating Manual – English 1.00



## Introduction

The RV-3 universal engine RPM and rotor RPM unit is a 3 1/8" instrument providing a universal RPM counter that can be adapted to a variety of roles. Typical uses are engine RPM displays or helicopter and gyroplane rotor RPM displays.

The RV-3 displays RPM in a digital readout as well as in a scalable analog bar graph display. In addition the RV-3 provides a 24 entry automatic flight log that stores the duration of each of the last 24 flights. It also has a Hobbs meter (can be set to the current engine time) which is password protected, an engine running timer/flight timer and a programmable maintenance timer to schedule routine engine maintenance. The RV-3 also features a programmable RPM low/high alarm as well as it records the maximum RPM reached in permanent memory.

## 1 Features

- Measures RPM from 0 to 20000 RPM
- Includes a 24 entry automatic flight log
- Includes a settable Hobbs meter (password protected) and an engine running timer/flight timer
- Contains a programmable low / high RPM alarm
- Contains a programmable maintenance timer for scheduled routine engine maintenance
- Records maximum RPM reached in permanent memory
- Scalable analog bar graph indicating RPM
- Standard 3 1/8" aircraft enclosure (can be front or rear mounted)
- Rotary control plus 2 independent buttons for easy menu navigation and user input
- External alarm output as well as a red LED illuminates when the alarm has been activated
- Large backlit graphic LCD with adjustable contrast
- Wide input supply voltage range of 8 to 30V DC with built in voltage reversal and over voltage protection for harsh electrical environments
- Light weight design
- 1 year limited warranty

## 2 RV-3 Layout

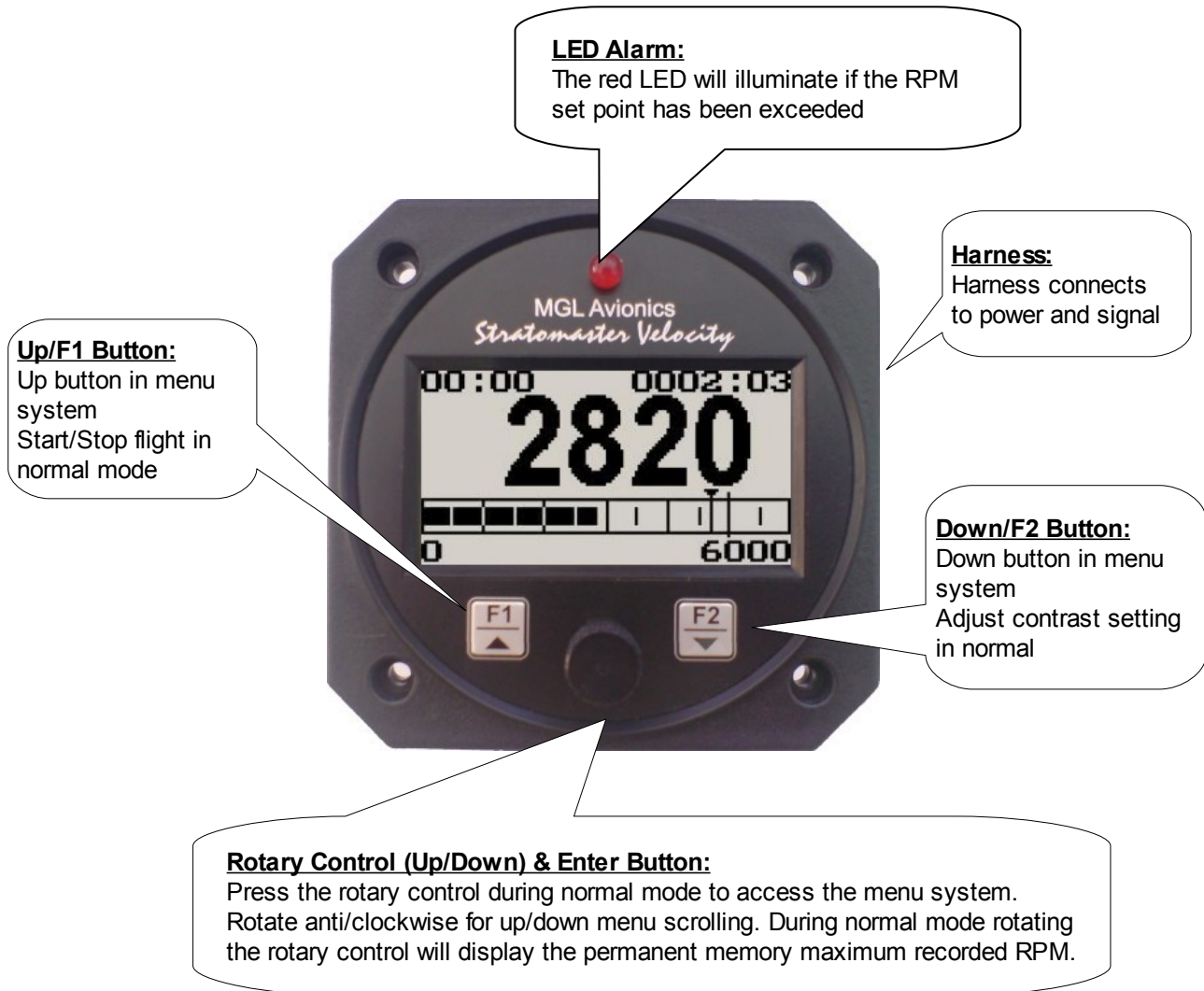

## 3 About RPM Measurements

Generally, there are two different methods of measuring RPM. The RV-3 unit can be setup to perform either method. The first method involves counting pulses generated by some device in the engine or from a sensor in case of Rotor RPM. Pulses are counted over a period of time and the result is then used to calculate RPM. This method requires a high number of pulses and a short measurement interval. The RV-3 counts pulses for  $\frac{1}{2}$  second. This method is suitable for most two stroke engines such as produced by Rotax.

Engines producing few pulses (perhaps only one pulse per revolution) and run at low revs, as well as slow turning rotors require a different method. Here the RV-3 can use the time it takes to generate only two pulses as bases for the RPM calculation. The particular method to be used and the number of pulses per revolution are entered as part of the RV-3 setup as given below.

## 4 Main Display

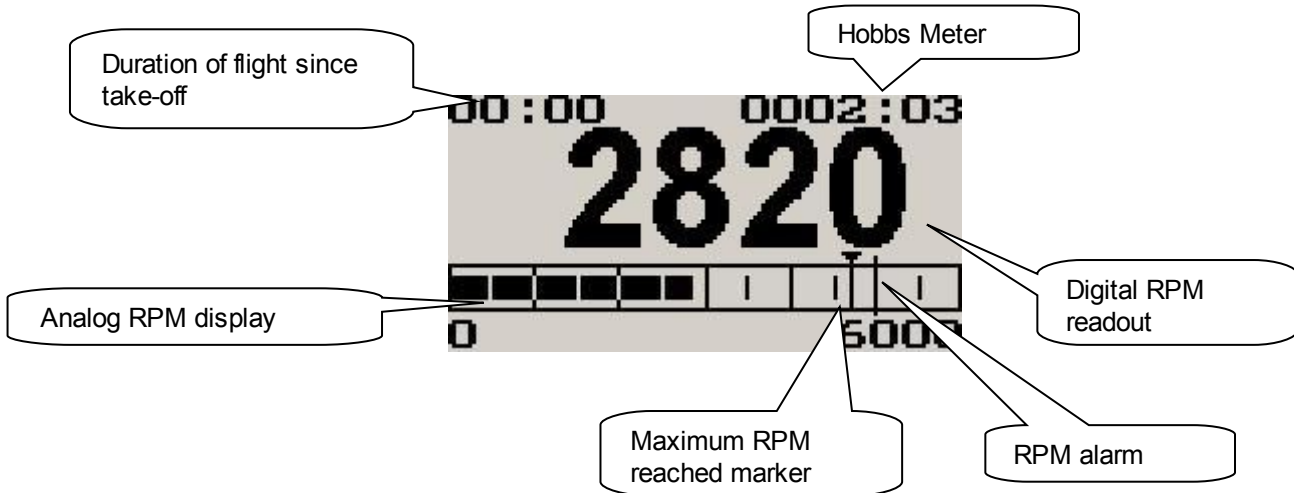

### 4.1 Start/Stop Flight Display



Press the F1 key during the normal display mode to manually start/stop a flight. This key is only active if the RV-3 is setup to select the manual flight option under the "FLIGHT LOG" setup menu.

### 4.2 Contrast Display

This display can be accessed by pressing the F2 key during the normal display mode. This is a quick access key to the same contrast menu as in the menu system.



Select this menu option to adjust the display contrast.

### 4.3 Maximum RPM Display

This display can be accessed by rotating the rotary control either clockwise or anticlockwise during the normal display mode. Pressing the F1 key again will reset the maximum RPM to the current RPM. Pressing any other key will cause the RV-3 to resume to the normal display mode. To avoid false recordings, the maximum RPM function is only activated 10 seconds after the instrument has powered up.



**Note:** The permanent maximum values are stored in non-volatile memory and are recalled on power-up.

## 5 Maintenance Timer

The purpose of this function is to assist you in determining remaining hours until maintenance will be required. It is not intended as a replacement for the aircraft's maintenance log. It is therefore important that the aircraft's maintenance log be maintained in the normal manner. You should further use your own discretion in performing maintenance earlier than indicated should any aircraft performance problems arise.

A maximum of 999 hours can be entered as a maintenance interval. The RV-3 will deduct actual engine running time from the maintenance interval hours as set and will display the reminder message on startup when zero hours are remaining. The reminder message will automatically disappear after 5 seconds or if the pilot presses any key. Engine running time for the purpose of the maintenance timer is defined as the run time where the engine RPM is greater than the preset RPM for the Hobbs meter.

MAINTENANCE  
TIMER HAS  
EXPIRED

## 6 Menu System

Pressing the rotary control button during the normal display mode will cause the RV-3 to enter the menu system. Use the up/down keys or the rotary control to navigate through the menu system.

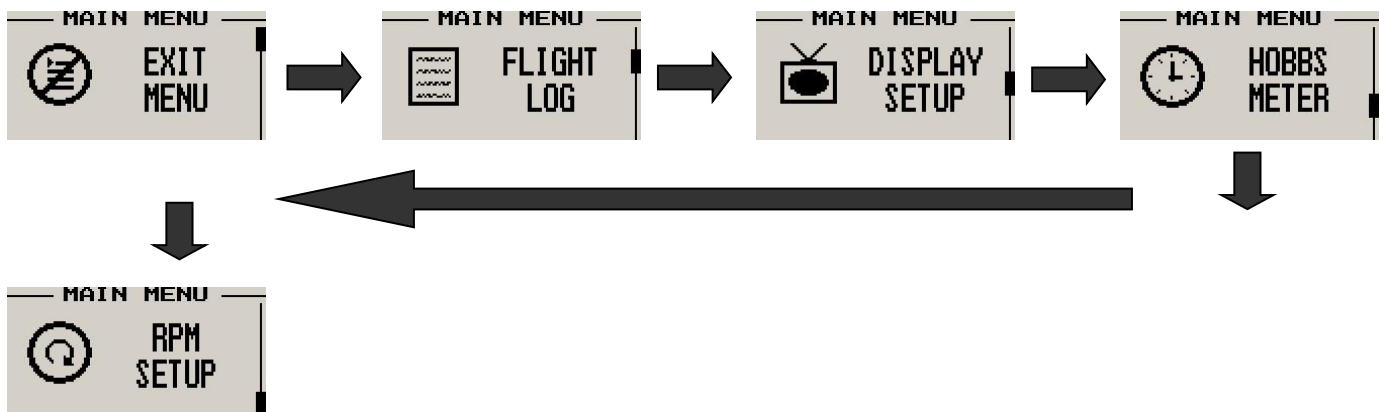

### 6.1 Exit Menu



Pressing the rotary control on this menu item will cause the RV-3 to exit the menu system. All changes made during navigation of the menu system will be saved in non-volatile memory on exiting the menu system. If you remove power before exiting the menu the instrument will not save any changes.

## 6.2 Flight Log



Select whether the instrument should detect the start and end of flights automatically or if you would like to do this manually. We recommend you select automatic flight detect. With automatic flight detection, flights will start logging when the engine RPM is above the take-off limit. A flight is considered ended when the engine RPM is less the RPM take-off limit for more then 30 seconds.



Move the highlight over the “DONE” option and press the rotary button to return to the main menu.



Select this function to view the flight log. The flight log contains the duration of each of the last 24 logged flights. Duration is displayed in hours and minutes. Eight flights are displayed at a time. Use the up/down or the rotary control to navigate through the log. Empty log entries are shown as “----”.

**Note:** You cannot select this function while a flight is in progress.



Pressing the F1 key will erase all the flight log entries.



Select whether you want the RV-3 to automatically detect a flight or whether the pilot must press the F1 key to start/stop a flight. We recommend you select automatic flight detection.



This menu option is only shown if the “detect” flight mode is selected. Enter the engine RPM take-off threshold that you want a flight log entry to start.

## 6.3 Display Setup



Move the highlight over the “DONE” menu option and press the rotary button to return to the main menu.

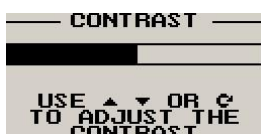

Select this menu option to adjust the display contrast.



Select this menu option to turn the backlight on or off.

## 6.4 Hobbs Meter



Move the highlight over the “DONE” menu option and press the rotary button to return to the main menu.



Enter the RPM limit in which the Hobbs meter/Maintenance timer must start counting.

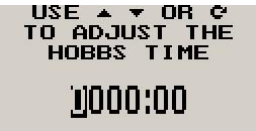
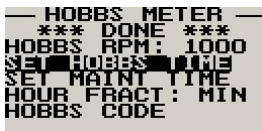

This function allows you to set the engine Hobbs meter to any value. Typically, you would use this function to set the Hobbs meter to the current known engine time. Use the up/down or the rotary control to change the value. Press the rotary control to accept and exit the menu option. If the Hobbs code is set to another value beside zero, then the pilot will be prompted to enter the Hobbs access code before allowing him to change the Hobbs time. This feature is useful for chartered and flying school planes.

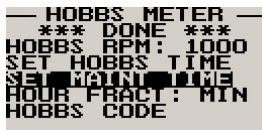

This function allows you to set an engine maintenance timer. This timer is set in engine hours and it will count down to zero when the engine RPM is greater then the Hobbs RPM limit. A good use for this function is to set the hours until your next spark plug change or engine inspection. Use the up/down or the rotary control to change the value. Press the rotary control to accept and exit the menu option.



Select if you would like the hour to be displayed in decimal fractions (0-99) or minutes (0-59). This setting influences the current flight time display and the flight log.



This menu option allows you to change the Hobbs access code. You will first be prompted to enter the current code followed by entering in a new code followed by re-entering the new code. If the new code and the re-entered code is the same, then the Hobbs access code will be changed. **Default code is 0000.**



## 6.5 RPM Setup



All the RPM related settings can be setup here.



Move the highlight over the “DONE” menu option and press the rotary button to return to the main menu.



Select the maximum value that you want the RPM analog bar graph display to show. This can give you increased display resolution.



Select whether you want the RPM low alarm to be turned on or off.



Enter the RPM alarm activation threshold. Any RPM value below this value will activate the alarm.



Select whether you want the RPM high alarm to be turned on or off.



Enter the RPM alarm activation threshold. Any RPM value above this value will activate the alarm.



Enter the number of pulses per RPM. For engines with an uneven number of cylinders like three cylinder four stroke engines you can enter values containing fractions (usually 1.5 in this example). Most four stroke engines would generate one pulse for every two revolutions per cylinder. A four cylinder automotive four stroke engine would thus generate 2 pulses per revolution. A typical Rotax DCDI two stroke engine would generate 6 pulses per revolution. The well known Rotax 912/914 engine generates one pulse per revolution.



PULSE: The RV-3 counts pulses from the engine for ½ second period (fast frequency input).  
 TIME: The RV-3 uses the time between pulses to calculate revs (slow frequency input).

### Typical setups:

- Rotax 503,582 DCDI – Pulse (Fast frequency) (6 pulses per revolution)
- Rotax 503 single ignition, Rotax 912/914 – Time (Slow frequency) (one pulse per revolution)
- Gyro Rotor RPM with gear tooth sensor - Pulse (Fast frequency) (about 100 pulses per revolution)
- Gyro Rotor RPM with single hall-effect sensor – Time (Slow frequency) (one pulse per revolution)
- Helicopter Rotor RPM with single hall-effect sensor – Time (Slow frequency) (one pulse per revolution)

```

RPM SETUP
LOW ALARM: OFF
LOW ALARM: 600
HIGH ALARM: ON
HIGH ALARM: 5000
PULSE/REV: 6.0
PULSE: PULSE
FILTER: SCALE
    
```

The RV-3 unit contains a digital filter. This filter is used to achieve a higher resolution of the digital rev counter than is available in ordinary operation. In digital rev counters, resolution is largely dependant on the amount of time given to measure RPM. The more time that is available, the higher the resolution will be. However, on the downside of this, the more sluggish the display will react to changes in engine settings. Resolution with the RV-3 is dependant on the number of pulses per rev and the type of measurement method you have selected (Pulse Pulse/Time). The update rate for the measurement is a fixed, fast 0.5 seconds. The digital filter is activated whenever input revs are fairly constant and this results in a very high resolution of the digital RPM display in a short time span. The filter needs to be setup for the expected base resolution. This can be between 10 and 30 RPM for most setups. The filter has the following settings:

**Scale** -The setting is made dependant on your scale selection from 500 to 20000 RPM. The filter factor is fixed as follows:

Scale 500 – 10 RPM	Scale 10000 – 200 RPM
Scale 1000 – 20 RPM	Scale 10500 – 210 RPM
Scale 1500 – 30 RPM	Scale 11000 – 220 RPM
Scale 2000 – 40 RPM	Scale 11500 – 230 RPM
Scale 2500 – 50 RPM	Scale 12000 – 240 RPM
Scale 3000 – 60 RPM	Scale 12500 – 250 RPM
Scale 3500 – 70 RPM	Scale 13000 – 260 RPM
Scale 4000 – 80 RPM	Scale 13500 – 270 RPM
Scale 4500 – 90 RPM	Scale 14000 – 280 RPM
Scale 5000 – 100 RPM	Scale 14500 – 290 RPM
Scale 5500 – 110 RPM	Scale 15000 – 300 RPM
Scale 6000 – 120 RPM	Scale 15500 – 310 RPM
Scale 6500 – 130 RPM	Scale 16000 – 320 RPM
Scale 7000 – 140 RPM	Scale 16500 – 330 RPM
Scale 7500 – 150 RPM	Scale 17000 – 340 RPM
Scale 8000 – 160 RPM	Scale 17500 – 350 RPM
Scale 8500 – 170 RPM	Scale 18000 – 360 RPM
Scale 9000 – 180 RPM	Scale 18500 – 370 RPM
Scale 9500 – 190 RPM	Scale 19000 – 380 RPM

**10,20,30,40,50,60,70,80,90,100** – The filter factor can be set to any of these values independent of your scale selection. Choose a filter setting that results in a smooth, high resolution RPM display. A filter setting too low for your setup will result in a “jumpy” display. RPM display will change at your base resolution and no smoothing will happen. Choose the lowest setting that will result in a smooth display for greatest sensitivity of the reading.

## 7 Loading factory default settings

Pressing and holding the F1 and F2 simultaneously on power up will cause the RV-3 to load preprogrammed factory default settings. The following screen will be displayed:

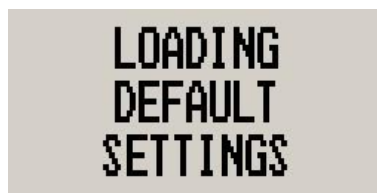



## 8 Operating the alarms

If the alarm is activated, the corresponding item on the display will flash. At the same time the externally available alarm switch will close. The switch will remain closed until any button is pressed to acknowledge the alarm or until the condition(s) that activated the alarm no longer exist. The alarm output can be used to switch an external alarm indicator. The external alarm switch is an open collector transistor switch to ground with a maximum rating of 0.5A DC. It is possible to wire the alarm contacts of several Stratomaster instruments in parallel should this be desired. To avoid false activation of the alarms, the alarm function is only active 10 seconds after the instrument has powered up.

## 9 Cleaning

The unit should not be cleaned with any abrasive substances. The screen is very sensitive to certain cleaning materials and should only be cleaned using a clean, damp cloth.

**Warning:** The RV-3 is not waterproof. Serious damage could occur if the unit is exposed to water and/or spray jets.

## 10 RV-3 Specifications

<b>Operating Temperature Range</b>	-10°C to 50°C (14°F to 122°F)
<b>Storage Temperature Range</b>	-20°C to 80°C (-4°F to 176°F)
<b>Humidity</b>	<85% non-condensing
<b>Power Supply</b>	8 to 30Vdc SMPS (switch mode power supply) with built in 33V over voltage and reverse voltage protection
<b>Current Consumption</b>	Approx. 43mA @ 13.8V (backlight on) 14mA @13.8V (backlight off)
<b>Display</b>	128x64 graphic LCD display. Contrast and backlight is user configurable, green/yellow backlight
<b>Dimensions</b>	see Velocity series dimensional drawing
<b>Enclosure</b>	3 1/8" ABS, black in color, front or rear mounting
<b>Weight</b>	Approx. 168 grams
<b>Alarm contact current rating</b>	Open collector transistor switch to ground. Maximum rating 0.5A DC
<b>Non-volatile memory storage</b>	100000 write cycles
<b>Rev counter input</b>	Range: 0-20000 RPM. Minimum signal for stable display: 5Vpp. Fully A/C coupled, maximum voltage +/- 40V. RF noise filter plus Schmitt-trigger based input

## 11 Installation

After you have connected the rev counter terminal to the signal source you need to set the number of pulses per revolution under the "RPM SETUP" menu. The calibration itself depends on your engine type and what kind of signal you are using. Typical sources are:

- Magneto coils (suitable signal at the kill switch)
- Primary (low voltage) side of ignition coil, at contact breaker or electronic ignition module
- RPM counter output of electronic ignition systems (for example Bosch Motronic)
- RPM pickup devices such as hall-effect sensors on flywheels etc.

Installation of the RV-3 is quite straight forward in most cases. The drawing in section 11.2 shows a typical RV-3 installation. Please see the engine connection diagrams for the RPM connection to the RV-3. The RV-3 input is quite universally usable. The rev counter input on the RV-3 can be used with signals from about 5Vpp to as much as 100Vpp and the input is AC coupled for easy installation. A noise filter is included that results in the input ignoring any noise

signals as long as this is below the detection threshold of about 2.5Vpp. The input impedance of the rev counter input is approximately 10Kohm. You can use series resistors as well as load resistors for applications that have unusual signals.

For installations such as with the Rotax DCDI two-stroke engines, the rev counter input is simply connected to the grey rev counter wire from the engine. These engines produce six pulses per rev (set this up in the relevant menu item). Most engines produce 0.5, 1 or 2 pulses per revolution. This needs to be setup in the "RPM SETUP" menu item.

**Please note: The +5V supply line is unprotected and intended only for the supply of a hall-effect , optical or gear tooth sensors. Connecting any voltages (such as the 12V supply) to this line could destroy the instrument. The +5V line may supply currents of up to 30mA. Should your sensor require greater currents you must supply it from another source.**

**Please note: It is essential that a single wire be connected from the minus terminal of the instrument to the engine block. This wire must not be used to share currents with other electrical users as this can affect accuracy of readings.**

## 11.1 Adjusting RPM sensitivity

The RV-3 has a sensitivity adjustment trimmer as shown in the picture below. Adjust this trimmer using a small screwdriver such that you get stable RPM readings over the entire rev band of your engine. If your sensitivity is too high, you may get unstable RPM readings (usually at higher RPM as electrical noise in the ignition system increases). If the sensitivity is too low the RPM reading may remain at zero. Fully clockwise = maximum sensitivity.

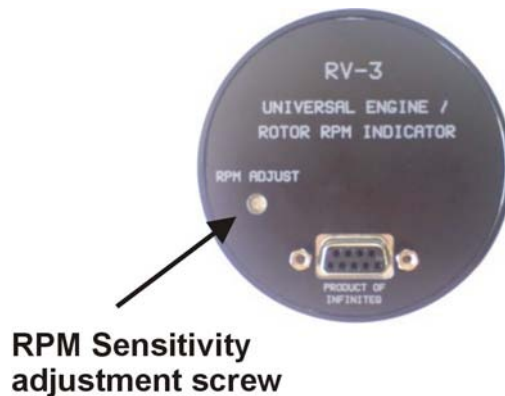

## 11.2 RV-3 DB9 Cable connections

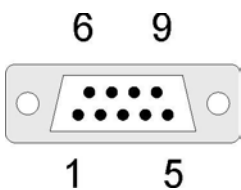

DB 9 Pin	Color	Function
1	Black	Ground
4	NC	Airtalk communication (Not connected) Used for firmware upgrading
5	Blue	RPM input
6	Red	8-30Vdc power
7	Brown	+5VDC Power Out
9	White	Alarm Output

### 11.3 RV-3 General Connection Diagram

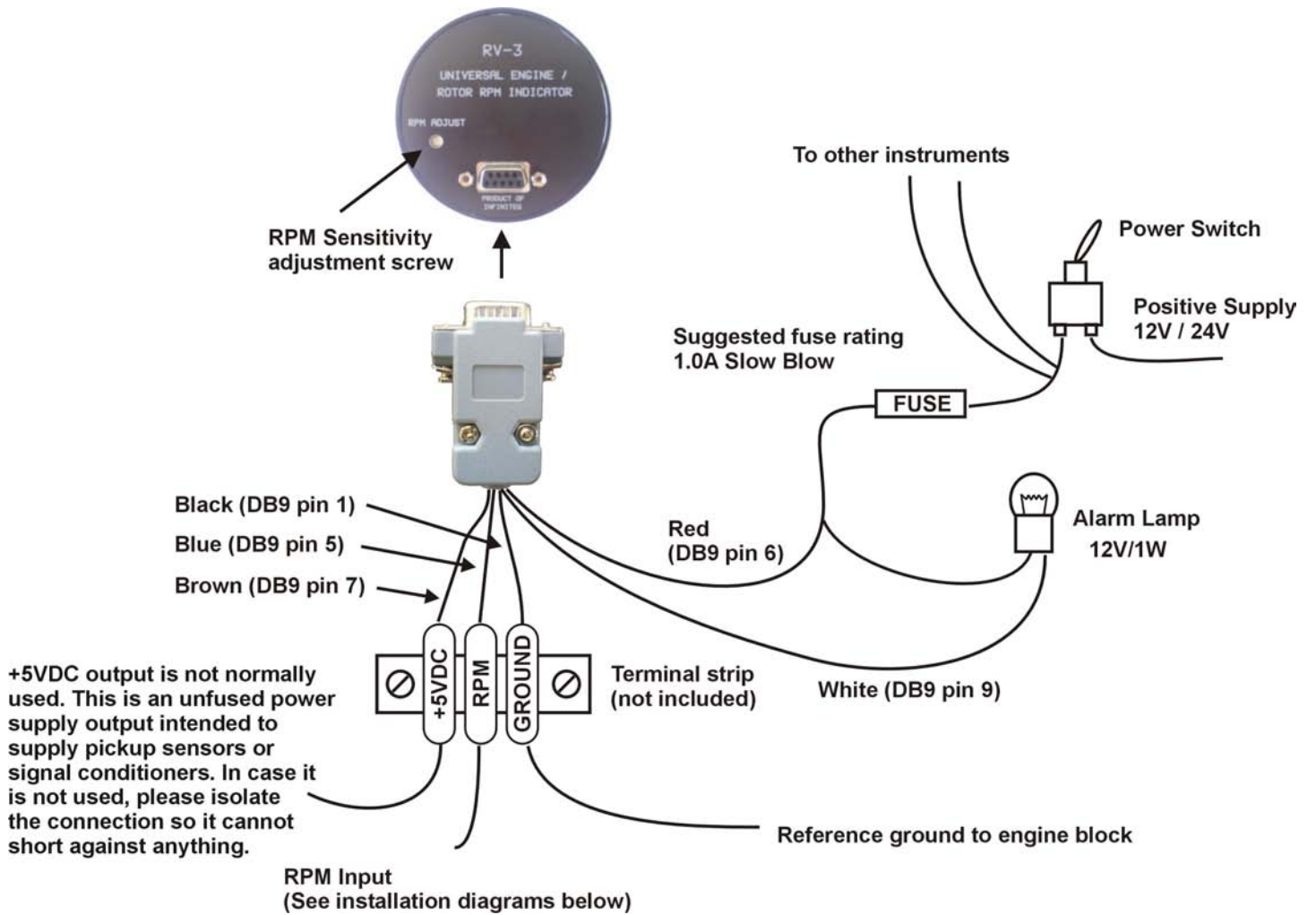

The use of an external 1A fuse is recommended. Connect the supply terminals to your aircraft's power supply. The RV-3 can be used on both 12V and 24V without the use of any pre-regulators. Ensure that the supply voltage will not drop below 8V during operation as this may result in incorrect readings.

### 11.4 Connecting the RV-3 to automotive engines

#### Conventional contact breaker ignition system

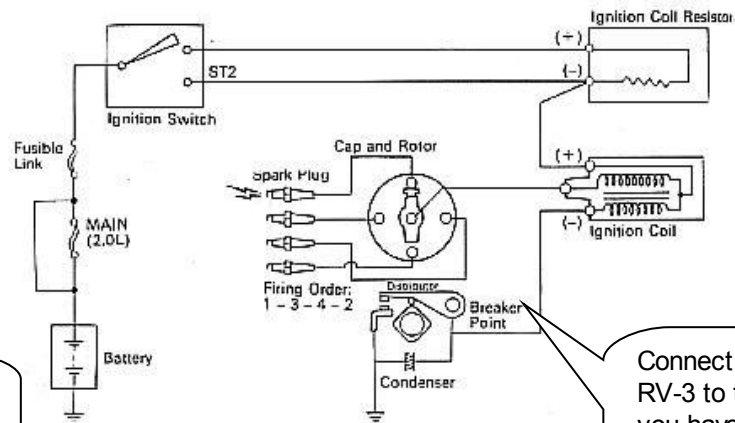

Use the tacho line if your system has such a signal

Connect rev counter input of RV-3 to this line. Ensure you have a connection from the RV-3 ground to the engine block.

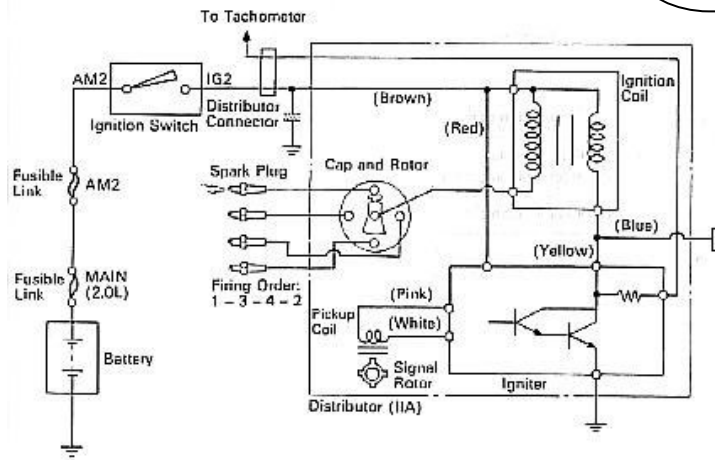

Connect rev counter input of RV-3 to this line. Ensure you have a connection from the RV-3 ground to the engine block.

#### Electronic ignition system with conventional ignition coil

## 11.5 Connecting the RV-3 to a 2 stroke Rotax engine

Typical connection in case of a Rotax two stroke engine with Ducati dual ignition:

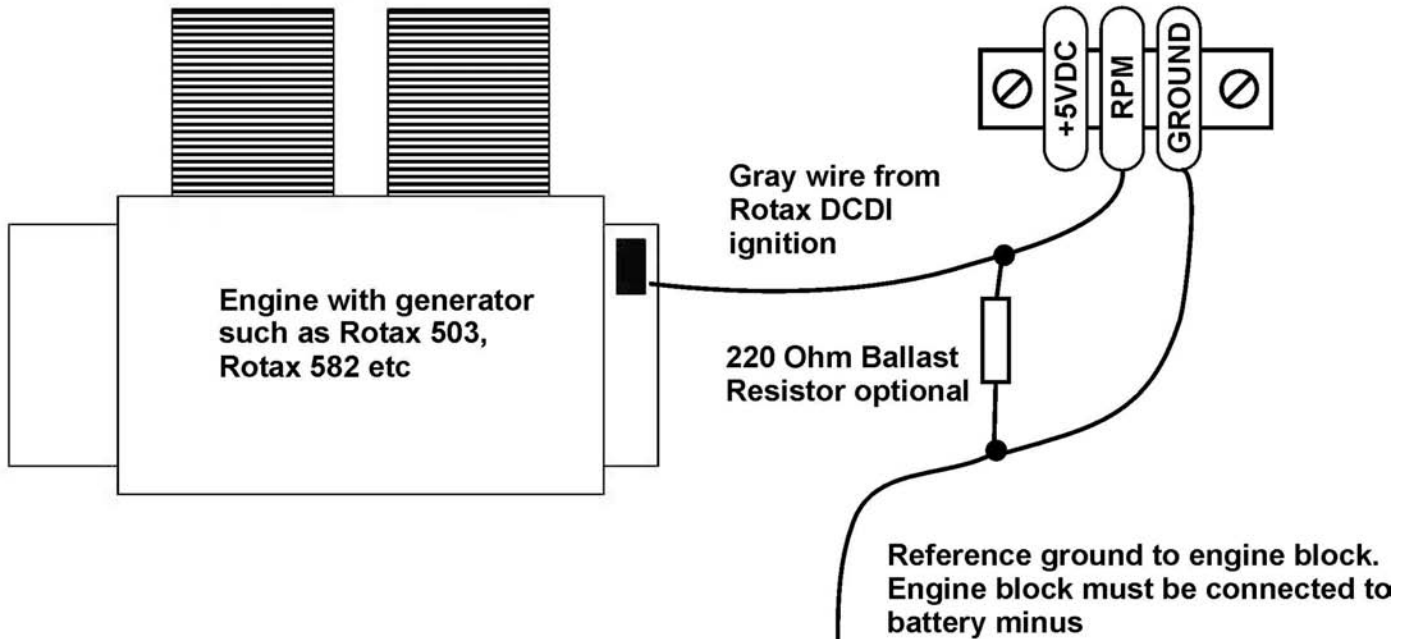

The follow values must be used for the pulses per revolution under the "RPM SETUP" menu.

**Rotax 503,582,618 DCDI** - value 6.0

**Rotax 912,914** - value 1.0

**Note:** Some Rotax engines may require that a 220 ohm ballast resistor is fitted between the rev counter input and the ground terminal. This resistor should be fitted if you cannot obtain stable RPM throughout the range regardless of any setting of the rev counter sensitivity adjustment.

### 11.6 Connecting the RV-3 to a Rotax 912/914

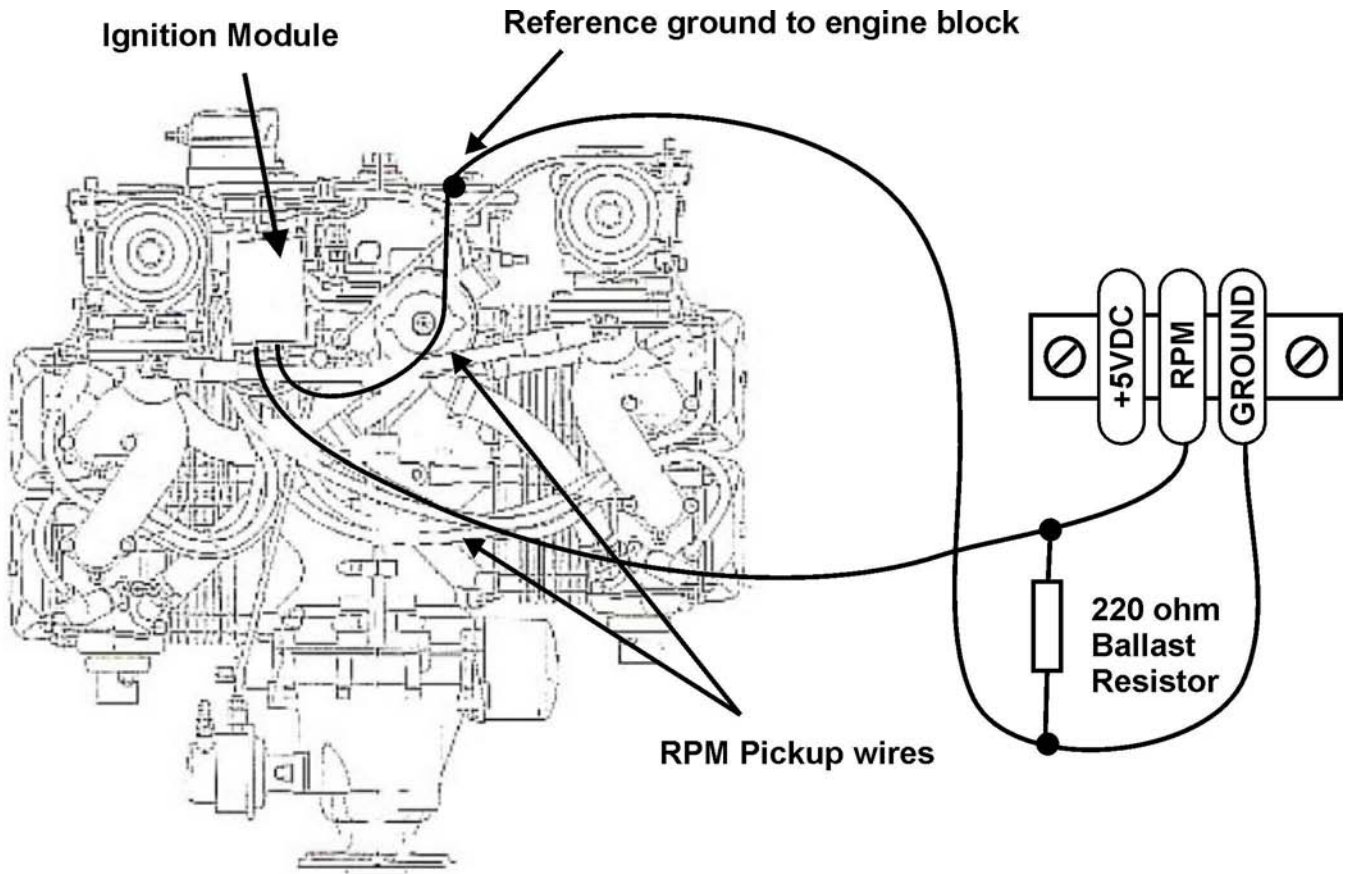

Connect the rev counter wires (blue/yellow and white/yellow) as follows: One of the two wires needs to be connected to ground (engine block), the other to the RPM counter input. For this engine we recommend that you use the supplied 220 ohm ballast resistor. Select a value of 1.0 for pulses per revolution under the "RPM SETUP" menu.

## 11.7 Connecting a Bendix magneto as a RPM source

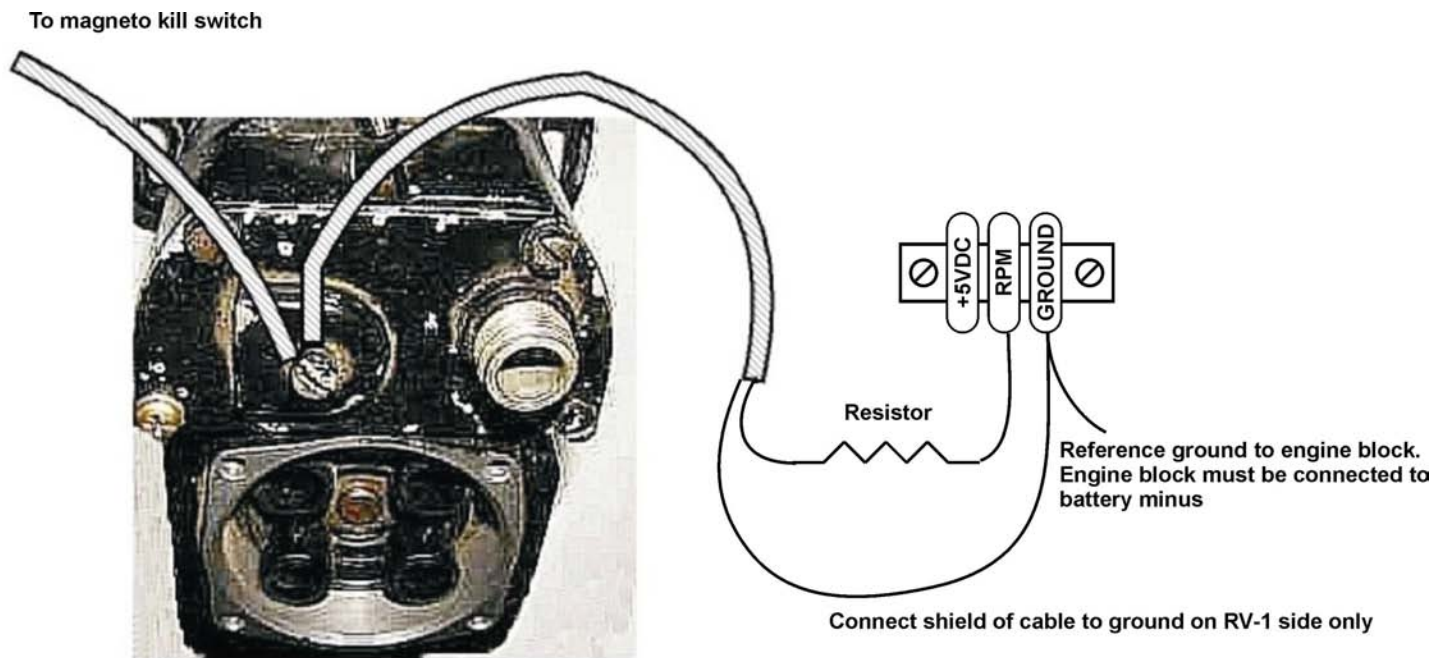

Typical connection to a Bendix P-Terminal. This terminal will have a wire going to your magneto kill switch or starter switch. Please note that various kinds of terminals are used on the many different types of Bendix magnetos

The above drawing shows the connection required if you would like to connect a magneto as RPM source. Shown is a typical Bendix magneto as used on Lycoming and other aircraft engines. You should find a wire connected to a terminal on the magneto that originates from your magneto kill switch (or starter switch). The terminal is often referred to as a "P-terminal". Connect a wire as shown and connect this to the RPM input of the RV-3. We strongly recommend that a resistor is inserted into your wire as shown. A good value would be 10.000 ohms (10K). A normal 1/4 W resistor is just fine. The above circuit can also be used on other magneto systems such as found on Jabiru and similar engines.

The supplied 220 Ohm ballast resistor should not be used on the above installation.

### 11.8 Various other pickup/sensor installation possibilities

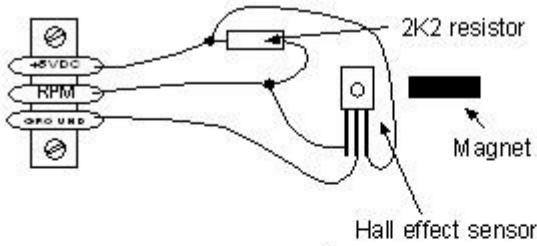

Typical hall effect sensor installation detects the passing of a magnet suitably fixed to prop flanges or shafts.

Magnetic pickup with Hall effect sensor

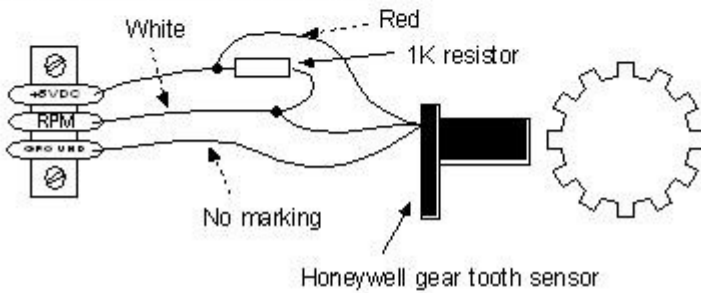

The gear tooth sensor is a popular pickup used on the pre-rotation gear of a gyro plane (rotor speed indication).

Magnetic pickup with active gear tooth sensor

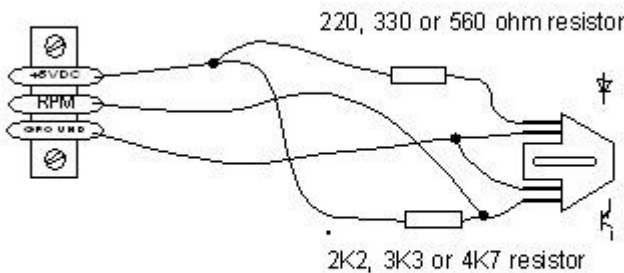

The optical reflective pickup can provide a simple means of contactless RPM sensing in difficult installations.

Optical, reflective sensor

## 12 Warranty

This product carries a warranty for a period of one year from date of purchase against faulty workmanship or defective materials, provided there is no evidence that the unit has been mishandled or misused. Warranty is limited to the replacement of faulty components and includes the cost of labour. Shipping costs are for the account of the purchaser.

**Note:** Product warranty excludes damages caused by unprotected, unsuitable or incorrectly wired electrical supplies and or sensors, and damage caused by inductive loads.



## 13 Disclaimer

Operation of this instrument is the sole responsibility of the purchaser of the unit. The user must make themselves familiar with the operation of this instrument and the effect of any possible failure or malfunction.

This instrument is not certified by the FAA. Fitting of this instrument to certified aircraft is subject to the rules and conditions pertaining to such in your country. Please check with your local aviation authorities if in doubt. This instrument is intended for ultralight, microlight, homebuilt and experimental aircraft. Operation of this instrument is the sole responsibility of the pilot in command (PIC) of the aircraft. This person must be proficient and carry a valid and relevant pilot's license. This person has to make themselves familiar with the operation of this instrument and the effect of any possible failure or malfunction. Under no circumstances does the manufacturer condone usage of this instrument for IFR flights.

The manufacturer reserves the right to alter any specification without notice.

## Other instruments in the *Stratomaster Velocity* series

<b>ALT-3</b>	Encoding aviation altimeter and Vertical speed indicator (VSI)
<b>ALT-4</b>	Encoding aviation altimeter with Serial RS232 & Parallel Gillham code output
<b>ASI-3</b>	Airspeed indicator (ASI) with automatic flight log
<b>ASX-2</b>	Encoding aviation altimeter and Airspeed indicator (ASI)
<b>AV-2</b>	Artificial horizon and magnetic compass indicator
<b>E-1</b>	Universal engine monitor
<b>FLIGHT-2</b>	Primary Flight instrument
<b>FF-3</b>	Fuel Computer (single or dual fuel tanks)
<b>GF-2</b>	+/-10G tilt compensated dual range G-force meter
<b>MAP-2</b>	Manifold pressure and RPM Indicator
<b>ROTOR-1</b>	Dual Rotor / Engine tachometer
<b>RTC-1</b>	Aviation real time clock (RTC), outside air temperature (OAT) and Voltage display
<b>RV-3</b>	Universal engine / Rotor RPM Indicator
<b>TC-2</b>	4-Channel thermocouple (EGT/CHT) indicator
<b>TC-3</b>	12-Channel thermocouple (EGT/CHT) indicator
<b>TP-2</b>	Universal temperature and pressure gauge